



**Bobcat®**

EN

---

## Operation & Maintenance Manual S70 Skid-Steer Loader

---

S/N A3W711001 & Above

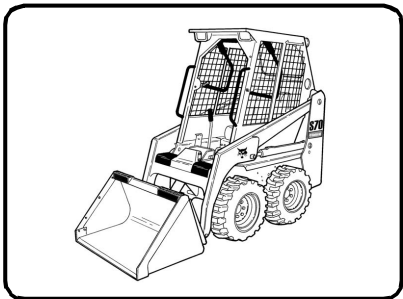

EQUIPPED WITH  
BOBCAT INTERLOCK  
CONTROL SYSTEM (BICS™)

698660-EN (11-10) Revised (11-11) (6)

Printed in Belgium  
Original Instructions



© Bobcat Company 2011

\*AAA Rent-All 225-291-1356\*



**\*Always follow manufacturer instructions\***

**d** Torkonjestraat 23  
8510 Marke  
Belgium

 056 / 222 111

 rental@dumarent.be

 www.dumarent.be

**\*AAA Rent-All 225-291-1356\***

## OPERATOR SAFETY WARNINGS



**▲ Safety Alert Symbol:** This symbol with a warning statement, means: "Warning, be alert! Your safety is involved!" Carefully read the message that follows.

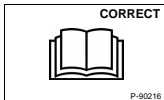

**▲** Never use the loader without instructions. See machine signs (decals), Operation & Maintenance Manual, and Operator's Handbook.

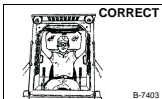

**▲** Always use the seat bar and fasten seat belt snugly.  
**▲** Always keep feet on the foot pedals or footrests when operating loader.

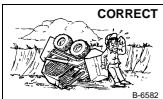

**▲** Never use loader without operator cab with ROPS and FOPS approval. Fasten your seat belt.



**▲** Never use loader as a man lift or elevating device for personnel.



**▲** Do not use loader in atmosphere with explosive dust, explosive gas, or where exhaust can contact flammable material.



**▲** Never carry riders.  
**▲** Keep bystanders away from work area.



**▲** Always carry bucket or attachments as low as possible.  
**▲** Do not travel or turn with lift arms up.  
**▲** Load, unload, and turn on flat level ground.

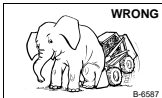

**▲** Never exceed Rated Operating Capacity.



**▲** Never leave loader with engine running or with lift arms up.  
**▲** To park, engage parking brake and put attachment flat on the ground.



**▲** Never modify equipment.  
**▲** Use only attachments approved by Bobcat Company for this model loader.

### SAFETY EQUIPMENT

The Bobcat Loader must be equipped with safety items necessary for each job. Ask your dealer for information on the safe use of attachments and accessories.

1. SEAT BELT: Check belt fasteners and check for damaged webbing or buckle.
2. SEAT BAR: When up, it must lock the loader controls.
3. OPERATOR CAB (ROPS and FOPS): It must be on the loader with all fasteners tight.
4. OPERATOR'S HANDBOOK: Must be in the cab.
5. SAFETY SIGNS (DECALS): Replace if damaged.
6. SAFETY TREADS: Replace if damaged.
7. GRAB HANDLES: Replace if damaged.
8. LIFT ARM SUPPORT DEVICE: Replace if damaged.
9. PARKING BRAKE
10. BOBCAT INTERLOCK CONTROL SYSTEM (BICS)

OSW03-0409



**\*Always follow manufacturer instructions\***

**d** Torkonjstraat 23  
8510 Marke  
Belgium



056 / 222 111



rental@dumarent.be



www.dumarent.be



**Bobcat**®

**d** Torkonjestraat 23  
8510 Marke  
Belgium

☎ 056 / 222 111  
✉ rental@dumarent.be  
📞 www.dumarent.be

**CONTENTS**

FOREWORD ..... 5

SAFETY & TRAINING RESOURCES ..... 17

OPERATING INSTRUCTIONS ..... 29

PREVENTIVE MAINTENANCE ..... 69

SYSTEM SETUP & ANALYSIS ..... 113

SPECIFICATIONS ..... 119

WARRANTY ..... 125

ALPHABETICAL INDEX ..... 129

**REFERENCE INFORMATION**

Write the correct information for YOUR Bobcat loader in the spaces below. Always use these numbers when referring to your Bobcat loader.

Loader Serial Number \_\_\_\_\_  
Engine Serial Number \_\_\_\_\_

NOTES:

\_\_\_\_\_  
\_\_\_\_\_  
\_\_\_\_\_

YOUR BOBCAT DEALER:

ADDRESS:

PHONE:

\_\_\_\_\_



Bobcat Company  
P.O. Box 128  
Gwinner, ND 58040-0128  
UNITED STATES OF AMERICA

Doosan Benelux SA  
Drève Richelle 167  
B-1410 Waterloo  
BELGIUM



**Bobcat**®



**Torkonjestraat 23**  
**8510 Marke**  
**Belgium**



**056 / 222 111**



**rental@dumarent.be**



**www.dumarent.be**

**FOREWORD**

This Operation & Maintenance Manual was written to give the owner / operator instructions on the safe operation and maintenance of the Bobcat loader. **READ AND UNDERSTAND THIS OPERATION & MAINTENANCE MANUAL BEFORE OPERATING YOUR BOBCAT LOADER.** If you have any questions, see your Bobcat dealer. This manual may illustrate options and accessories not installed on your loader.

DECLARATION OF CONFORMITY .....	7
BOBCAT COMPANY IS ISO 9001 CERTIFIED .....	9
REGULAR MAINTENANCE ITEMS .....	9
LUBRICANTS AND FLUIDS .....	10
SERIAL NUMBER LOCATIONS .....	11
Loader Serial Number .....	11
Engine Serial Number .....	11
DELIVERY REPORT .....	11
LOADER IDENTIFICATION .....	12
FEATURES, ACCESSORIES AND ATTACHMENTS .....	13
Standard Items .....	13
Options And Accessories .....	13
Buckets Available .....	14
Attachments .....	14
Special Applications Kit .....	15
Special Applications Kit Inspection And Maintenance .....	15



Torkonjstraat 23  
8510 Marke  
Belgium



056 / 222 111



rental@dumarent.be



www.dumarent.be



**Bobcat**®



**d** Torkonjestraat 23  
8510 Marke  
Belgium

056 / 222 111  
 rental@dumarent.be  
 www.dumarent.be

**DECLARATION OF CONFORMITY**

<b>Contents of EC Declaration of Conformity</b>					
<p>This information is provided in the operators manual to comply with clause 1.7.4.2(c) of Annex I of Machinery Directive 2006/42/EC.</p> <p>The official EC Declaration of Conformity is supplied in a separate document.</p>					
<p><b>Manufacturer</b></p> <p>Bobcat Company World Headquarters 250 East Beaton Drive West Fargo, ND 58078-6000 UNITED STATES OF AMERICA</p>	<p><b>Directive 2000/14/EC: Noise Emission in the Environment by Equipment For Use Outdoors</b></p> <p><b>Notified Body</b> Technical and Test Institute for Construction Prague, Czech Republic Notified Body Number: 1020</p> <p><b>EC Certificate No.</b> 1020-090-022395</p> <p><b>Conformity Assessment Procedure(s)</b> 2000/14/EC, Annex VIII, Full Quality Assurance</p> <p><b>Sound Power Levels [Lw(A)]</b></p> <table style="width: 100%;"> <tr> <td>Measured Sound Power</td> <td style="text-align: right;">96 dBA</td> </tr> <tr> <td>Guaranteed Sound Power</td> <td style="text-align: right;">101 dBA</td> </tr> </table>	Measured Sound Power	96 dBA	Guaranteed Sound Power	101 dBA
Measured Sound Power	96 dBA				
Guaranteed Sound Power	101 dBA				
<p><b>Technical Documentation</b> Doosan Benelux SA Drève Richelle 167 B-1410 Waterloo BELGIUM</p>	<p><b>Equipment conforms to CE Directive(s) Listed Below</b> 2006/42/EC: Machinery Directive 2004/108/EC: Electromagnetic Compatibility Directive</p>				
<p><b>Description of Equipment</b> Type of Equipment: Wheeled Loader Model Name: S70 Model Code: A3W7</p> <p>Engine Manufacturer: Kubota Engine Model: V1005-E3B-BC-3 Engine Power: 17,2 kW @ 3000 RPM</p>	<p><b>Declaration of Conformance</b> This equipment conforms to the requirements specified in all the EC Directives listed in this declaration.</p>				
<p><b>Effective From:</b> 29 December 2009</p>					



**Bobcat**®

**BOBCAT COMPANY IS ISO 9001 CERTIFIED**









ISO 9001 is an international standard that specifies requirements for a quality management system that controls the processes and procedures which we use to design, develop, manufacture and distribute Bobcat products.

British Standards Institute (BSI) is the Certified Registrar Bobcat Company chose to assess the Company's compliance with the ISO 9001 at Bobcat's manufacturing facilities in Gwinner and Bismarck, North Dakota (U.S.A.), Pontchateau (France), Dobris (Czech Republic) and the Bobcat corporate offices (Gwinner, Bismarck & West Fargo) in North Dakota. Only certified assessors, like BSI, can grant registrations.

ISO 9001 means that as a company we say what we do and do what we say. In other words, we have established procedures and policies, and we provide evidence that the procedures and policies are followed.

**REGULAR MAINTENANCE ITEMS**

	ENGINE OIL FILTER (6 Pack) 6657635		BREATHER CAP 6684923
	FUEL FILTER 6667352		BATTERY 6674687
	AIR FILTER, Outer 6672467		HYDROSTATIC FILTER 6677652
	AIR FILTER, Inner 6672468		

**NOTE:** Always verify Part Numbers with your Bobcat dealer.



**SERIAL NUMBER LOCATIONS**

Always use the serial number of the loader when requesting service information or when ordering parts. Early or later models (identification made by serial number) may use different parts, or it may be necessary to use a different procedure in doing a specific service operation.

**Figure 1**



**Loader Serial Number**

The loader serial number plate (Item 1) [Figure 1] is located inside the cab on the right-hand side.

**Figure 2**

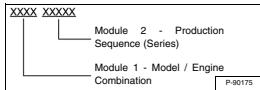

Explanation of loader Serial Number [Figure 2]:

1. The four digit Model / Engine Combination Module number identifies the model number and engine combination.
2. The five digit Production Sequence Number identifies the order which the loader is produced.

**Engine Serial Number**

**Figure 3**

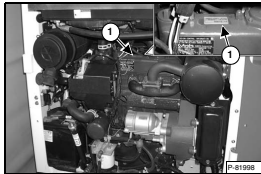

The engine serial number is located on top of the engine (Item 1) [Figure 3].

**DELIVERY REPORT**

**Figure 4**

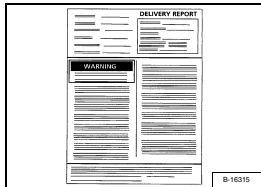

The delivery report [Figure 4] must be completed by the dealer and signed by the owner or operator when the Bobcat Loader is delivered. An explanation of the form must be given to the owner.

**LOADER IDENTIFICATION**

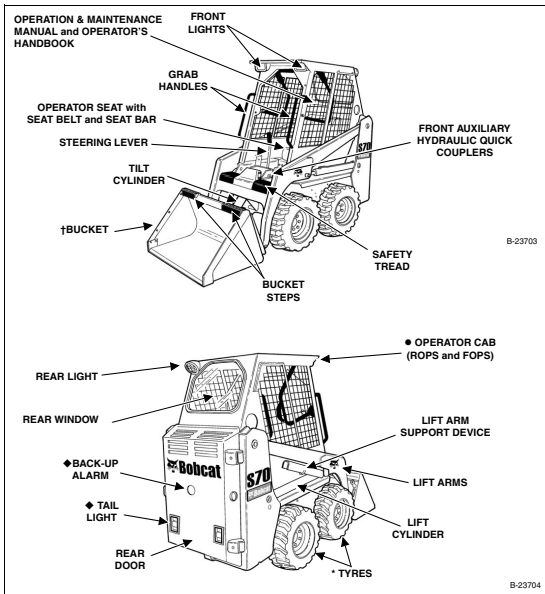

- ◆ OPTIONAL OR FIELD ACCESSORY (Not Standard Equipment).
- \* TYRES - Bobcats are base-equipped with standard tyres.
- † BUCKET - Several different buckets and other attachments are available for the Bobcat Loader.
- ROPS, FOPS - Roll Over Protective Structure, per ISO 3471, and Falling Object Protective Structure per ISO 3449, Level I.

#### FEATURES, ACCESSORIES AND ATTACHMENTS

##### Standard Items

Model S70 Bobcat Loaders are equipped with the following standard items:

- Adjustable Suspension Seat
- Auxiliary Hydraulics, Front
- Bobcat Interlock Control System (BICS™)
- Bob-Tach™
- CE Certification
- Engine / Hydraulic Systems Shutdown
- Front Horn
- Instrumentation: Hourmeter, Engine Temperature and Warning Lights
- Lift Arm Support Device
- Lights, Front and Rear
- Operator Cab (ROPS and FOPS Approved)
- Parking Brake
- Rear Window
- Seat Bar
- Seat Belt
- Sound Reduction Kit (Reduces noise at operator ear)
- Spark Arrester Exhaust System
- Tool Container
- Tyres (Bobcat Standard Duty, 23 x 5.70 - 12, 4 Ply Rating)
- Work Lights - Rear

##### Options And Accessories

Below is a list of some equipment available from your Bobcat Loader dealer as Dealer and / or Factory Installed Accessories and Factory Installed Options. See your Bobcat dealer for other available options, accessories and attachments.

- Attachment Control Kit
- Back-up Alarm
- Cab Door
- Cab Enclosure
- Cab Heater
- Catalytic Exhaust Purifier
- Engine Heater
- Fire Extinguisher
- Hydraulic Bucket Positioning (Includes On/Off Selection)
- Keyless Start
- Lift Kit (For lifting entire loader)
- Locking Fuel Cap and Cover
- Rear Stabiliser Kit
- Road Kit
- Rotating Beacon
- Seat Belt - 3 in. Wide
- Special Applications Kit
- Strobe Light
- Tyres:
  - Bobcat Heavy Duty, 23 x 8.50 - 12, 6 Ply Rating
- Vinyl Cab Enclosure
- Warning Lights: Four-Way Flasher (Includes Direction Signals)
- Windows
  - Externally Removable Rear Window
  - Polycarbonate Rear Window
  - Side Windows
  - Top Window

***Specifications subject to change without notice and standard items may vary.***

## FEATURES, ACCESSORIES AND ATTACHMENTS (CONT'D)

These and other attachments are approved for use on this model loader. Do not use unapproved attachments. Attachments not manufactured by Bobcat may not be approved.

The versatile Bobcat Loader quickly turns into a multi-job machine with a tight-fit attachment hook-up ... from bucket to grapple to pallet fork to backhoe and a variety of other attachments.

See your Bobcat dealer for information about approved attachments and attachment Operation & Maintenance Manuals.

Increase the versatility of your Bobcat Loader with a variety of bucket styles and sizes.

## Buckets Available

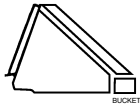

Many bucket styles, widths and different capacities are available for a variety of different applications. They include Construction & Industry, Low profile, Fertilizer and Snow, to name a few. See your Bobcat dealer for the correct bucket for your Bobcat Loader and application.

## Attachments

- Angle Broom
- Auger
- Backhoe
- Blades
  - Utility Blade
  - V-Blade
- Buckets
- Combination Bucket
- Cutter Crusher
- Digger
- Dumping Hopper
- Grapple, Utility
- Hydraulic Breaker
- Landplane
- Pallet Fork
- Scraper
- Snowblower
- Soil Conditioner
- Stump Grinder
- Sweeper
- Tiller
- Trencher
- Utility Forks
- X-Change™ Frame



## FEATURES, ACCESSORIES AND ATTACHMENTS (CONT'D)



### AVOID INJURY OR DEATH

Some attachment applications can cause flying debris or objects to enter front, top or rear cab openings. Install the Special Applications Kit to provide added operator protection in these applications.

W-2737-0508

## Special Applications Kit

Figure 5

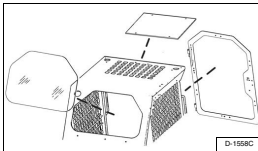

Available for special applications to restrict material from entering cab openings. Kit includes 12,7 mm (0.5 in) thick polycarbonate front door, 6,4 mm (0.25 in) thick polycarbonate top and rear windows [Figure 5].

See your Bobcat dealer for availability.

## Special Applications Kit Inspection And Maintenance

- Inspect for cracks or damage. Replace if required.
- Pre-rinse with water to remove gritty materials.
- Wash with a mild household detergent and warm water.
- Use a sponge or soft cloth. Rinse well with water and dry with a clean soft cloth or rubber squeegee.
- Do not use abrasive or highly alkaline cleaners.
- Do not clean with metal blades or scrapers.

**d** Torkonjstraat 23  
8510 Marke  
Belgium

☎ 056 / 222 111  
✉ rental@dumarent.be  
🌐 www.dumarent.be



**Bobcat®**

**d** **Torkonjestraat 23**  
**8510 Marke**  
**Belgium**



**056 / 222 111**



**rental@dumarent.be**



**www.dumarent.be**

**SAFETY & TRAINING RESOURCES**

<b>SAFETY INSTRUCTIONS</b> .....	<b>19</b>
Before Operation .....	19
Safe Operation Is The Operator's Responsibility .....	20
Safe Operation Needs A Qualified Operator .....	20
Avoid Silica Dust .....	21
<b>FIRE PREVENTION</b> .....	<b>21</b>
Maintenance .....	21
Operation .....	21
Electrical .....	21
Hydraulic System .....	22
Fueling .....	22
Starting .....	22
Spark Arrester Exhaust System .....	22
Welding And Grinding .....	22
Fire Extinguishers .....	22
<b>MACHINE SIGNS (DECALS)</b> .....	<b>24</b>
No-Text Safety Signs .....	26
<b>PUBLICATIONS AND TRAINING RESOURCES</b> .....	<b>27</b>



**\* Always follow manufacturer instructions \***

**d** Torkonjstraat 23  
8510 Marke  
Belgium



056 / 222 111



rental@dumarent.be



www.dumarent.be



**Bobcat®**

## SAFETY INSTRUCTIONS

### Before Operation

Carefully follow the operating and maintenance instructions in this manual.

The Bobcat loader is highly maneuverable and compact. It is rugged and useful under a wide variety of conditions. This presents an operator with hazards associated with off motorway, rough terrain applications, common with Bobcat loader usage.

The Bobcat loader has an internal combustion engine with resultant heat and exhaust. All exhaust gases can kill or cause illness so use the Loader with adequate ventilation.

The dealer explains the capabilities and restrictions of the Bobcat loader and attachment for each application. The dealer demonstrates the safe operation according to Bobcat instructional materials, which are also available to operators. The dealer can also identify unsafe modifications or use of unapproved attachments. The attachments and buckets are designed for a Rated Operating Capacity (some have restricted lift heights). They are designed for secure fastening to the Bobcat loader. The user must check with the dealer, or Bobcat literature, to determine safe loads of materials of specified densities for the machine - attachment combination.

The following publications and training materials provide information on the safe use and maintenance of the Bobcat machine and attachments:

- The Delivery Report is used to assure that complete instructions have been given to the new owner and that the machine and attachment is in safe operating condition.
- The Operation & Maintenance Manual delivered with the machine or attachment gives operating information as well as routine maintenance and service procedures. It is a part of the machine and can be stored in a container provided on the machine. Replacement Operation & Maintenance Manuals can be ordered from your Bobcat dealer.
- Machine signs (decals) instruct on the safe operation and care of your Bobcat machine or attachment. The signs and their locations are shown in the Operation & Maintenance Manual. Replacement signs are available from your Bobcat dealer.
- An Operator's Handbook is fastened to the operator cab of the loader. Its brief instructions are convenient to the operator. See your Bobcat dealer for more information on translated versions.

The dealer and owner / operator review the recommended uses of the product when delivered. If the owner / operator will be using the machine for a different application(s) he or she must ask the dealer for recommendations on the new use.

**SAFETY INSTRUCTIONS (CONT'D)**

**Safe Operation Is The Operator's Responsibility**

	<b>Safety Alert Symbol</b>
<p>This symbol with a warning statement means:                  "Warning, be alert! Your safety is involved!"                  Carefully read the message that follows.</p>	

	<b>WARNING</b>
---	----------------

Operator must have instructions before operating the machine. Untrained operators can cause injury or death.

W-2001-0502

<b>IMPORTANT</b>
------------------

This notice identifies procedures which must be followed to avoid damage to the machine.

I-2019-0284

	<b>DANGER</b>
---	---------------

The signal word DANGER on the machine and in the manuals indicates a hazardous situation which, if not avoided, will result in death or serious injury.

D-1002-1107

	<b>WARNING</b>
---	----------------

The signal word WARNING on the machine and in the manuals indicates a potentially hazardous situation which, if not avoided, could result in death or serious injury.

W-2044-1107

The Bobcat loader and attachment must be in good operating condition before use.

Check all of the items on the Bobcat Service Schedule Decal under the 8-10 hour column or as shown in the Operation & Maintenance Manual.

**Safe Operation Needs A Qualified Operator**

For an operator to be qualified, he or she must not use drugs or alcoholic drinks which impair alertness or coordination while working. An operator who is taking prescription drugs must get medical advice to determine if he or she can safely operate a machine.

*A Qualified Operator Must Do The Following:*

*Understand the Written Instructions, Rules and Regulations*

- The written instructions from Bobcat Company include the Delivery Report, Operation & Maintenance Manual, Operator's Handbook and machine signs (decals).
- Check the rules and regulations at your location. The rules may include an employer's work safety requirements. For driving on public roads, the machine must be equipped as stipulated by the local regulations authorising operation on public roads in your specific country. Regulations may identify a hazard such as a utility line.

*Have Training with Actual Operation*

- Operator training must consist of a demonstration and verbal instruction. This training is given by your Bobcat dealer before the product is delivered.
- The new operator must start in an area without bystanders and use all the controls until he or she can operate the machine and attachment safely under all conditions of the work area. Always fasten seat belt before operating.

*Know the Work Conditions*

- Know the weight of the materials being handled. Avoid exceeding the Rated Operating Capacity (ROC) of the machine. Material which is very dense will be heavier than the same volume of less dense material. Reduce the size of the load if handling dense material.
- The operator must know any prohibited uses or work areas, for example, he or she needs to know about excessive slopes.
- Know the location of any underground lines.
- Wear tight fitting clothing. Always wear safety glasses when doing maintenance or service. Safety glasses, respiratory equipment, hearing protection or Special Applications Kits are required for some work. See your Bobcat dealer about Bobcat Safety Equipment for your model.

## SAFETY INSTRUCTIONS (CONT'D)

### Avoid Silica Dust



Cutting or drilling concrete containing sand or rock containing quartz may result in exposure to silica dust. Use a respirator, water spray or other means to control dust.

## FIRE PREVENTION



### Maintenance

The machine and some attachments have components that are at high temperatures under normal operating conditions. The primary source of high temperatures is the engine and exhaust system. The electrical system, if damaged or incorrectly maintained, can be a source of arcs or sparks.

Flammable debris (leaves, straw, etc.) must be removed regularly. If flammable debris is allowed to accumulate, it can cause a fire hazard. Clean often to avoid this accumulation. Flammable debris in the engine compartment is a potential fire hazard.

The operator's area, engine compartment and engine cooling system must be inspected every day and cleaned if necessary to prevent fire hazards and overheating.

All fuels, most lubricants and some coolants mixtures are flammable. Flammable fluids that are leaking or spilled onto hot surfaces or onto electrical components can cause a fire.

### Operation

Do not use the machine where exhaust, arcs, sparks or hot components can contact flammable material, explosive dust or gases.

### Electrical



Check all electrical wiring and connections for damage. Keep the battery terminals clean and tight. Repair or replace any damaged part or wires that are loose or frayed.

Battery gas can explode and cause serious injury. Use the procedure in the Operation & Maintenance Manual for connecting the battery and for jump starting. Do not jump start or charge a frozen or damaged battery. Keep any open flames or sparks away from batteries. Do not smoke in battery charging area.

**FIRE PREVENTION (CONT'D)**

**Hydraulic System**

Check hydraulic tubes, hoses and fittings for damage and leakage. Never use open flame or bare skin to check for leaks. Hydraulic tubes and hoses must be properly routed and have adequate support and secure clamps. Tighten or replace any parts that show leakage.

Always clean fluid spills. Do not use petrol or diesel fuel for cleaning parts. Use commercial non-flammable solvents.

**Fueling**



Stop the engine and let it cool before adding fuel. No smoking! Do not refuel a machine near open flames or sparks. Fill the fuel tank outdoors.

**Starting**

Do not use ether or starting fluids on any engine that has glow plugs or air intake heater. These starting aids can cause explosion and injure you or bystanders.

Use the procedure in the Operation & Maintenance Manual for connecting the battery and for jump starting.

**Spark Arrester Exhaust System**

The spark arrester exhaust system is designed to control the emission of hot particles from the engine and exhaust system, but the muffler and the exhaust gases are still hot.

Check the spark arrester exhaust system regularly to make sure it is maintained and working properly. Use the procedure in the Operation & Maintenance Manual for cleaning the spark arrester muffler (if equipped).

**Welding And Grinding**

Always clean the machine and attachment, disconnect the battery, and disconnect the wiring from the Bobcat controllers before welding. Cover rubber hoses, battery and all other flammable parts. Keep a fire extinguisher near the machine when welding.

Have good ventilation when grinding or welding painted parts. Wear dust mask when grinding painted parts. Toxic dust or gas can be produced.

Dust generated from repairing non-metallic parts such as hoods, fenders or covers can be flammable or explosive. Repair such components in a well ventilated area away from open flames or sparks.

**Fire Extinguishers**



Know where fire extinguishers and first aid kits are located and how to use them. Inspect the fire extinguisher and service the fire extinguisher regularly. Obey the recommendations on the instructions plate.





### MACHINE SIGNS (DECALS)

Follow the instructions on all the Machine Signs (Decals) that are on the loader. Replace any damaged machine signs and be sure they are in the correct locations. Machine signs are available from your Bobcat Loader dealer.

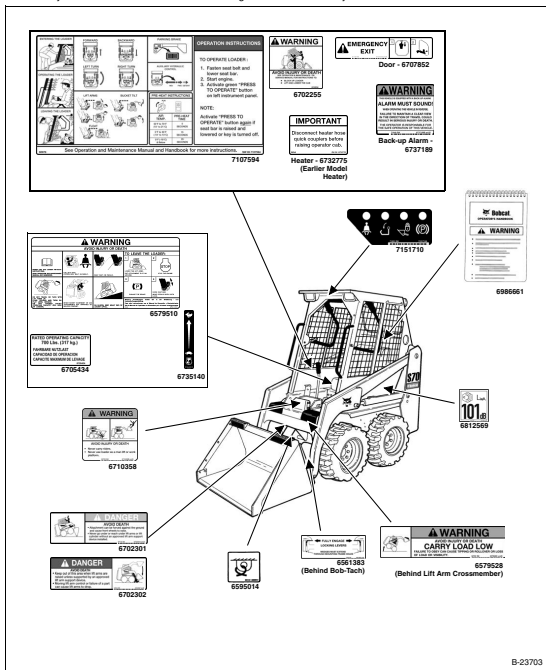

**MACHINE SIGNS (DECALS) (CONT'D)**

Follow the instructions on all the Machine Signs (Decals) that are on the loader. Replace any damaged machine signs and be sure they are in the correct locations. Machine signs are available from your Bobcat Loader dealer.

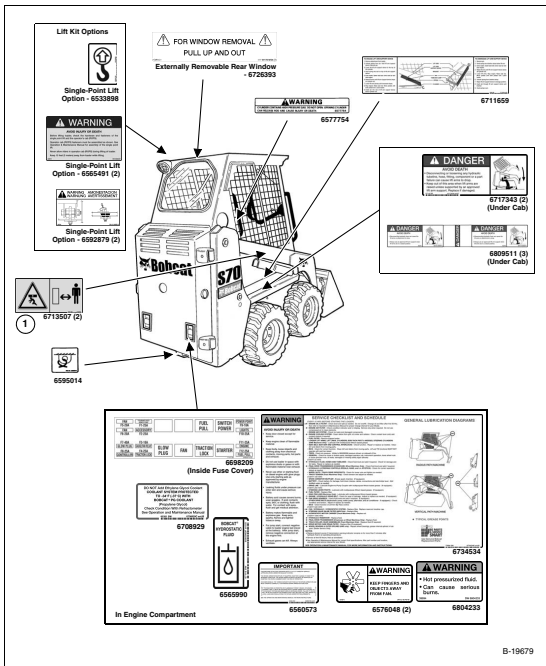



**MACHINE SIGNS (DECALS) (CONT'D)**

**No-Text Safety Signs**

Safety signs are used to alert the equipment operator or maintenance person to hazards that may be encountered in the use and maintenance of the equipment. The location and description of the safety signs are detailed in this section. Please become familiarized with all safety signs installed on the machine / attachment.

**NOTE:** See the numbered **MACHINE SIGNS (DECALS)** on Page 24 and **MACHINE SIGNS (DECALS) (CONT'D)** on Page 25 for the machine location of each correspondingly numbered no-text decal.

**1. Crush Hazard (6713507)**

This safety sign is located on the side of each lift arm.

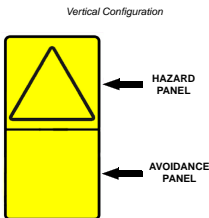

Keep away from the operating machine to avoid serious injury or death.

W-2520-0106

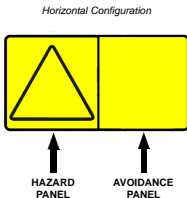

The format consists of the hazard panel(s) and the avoidance panel(s):

Hazard panels depict a potential hazard enclosed in a safety alert triangle.

Avoidance panels depict actions required to avoid the hazards.

A safety sign may contain more than one hazard panel and more than one avoidance panel.

**056 / 222 111****rental@dumarent.be****www.dumarent.be****PUBLICATIONS AND TRAINING RESOURCES**

The following publications are also available for your Bobcat loader. You can order them from your Bobcat dealer.

For the latest information on Bobcat products and the Bobcat Company, visit our web site at [www.training.bobcat.com](http://www.training.bobcat.com) or [www.bobcat.com](http://www.bobcat.com).

**OPERATION &  
MAINTENANCE  
MANUAL****6986660**

Complete instructions on the correct operation and the routine maintenance of the Bobcat loader.

**S70 SERVICE  
MANUAL****6986662**

Complete maintenance instructions for your Bobcat loader.

**OPERATOR'S  
HANDBOOK****6986661**

Gives basic operation instructions and safety warnings.

**d** Torkonjstraat 23  
8510 Marke  
Belgium

☎ 056 / 222 111  
✉ rental@dumarent.be  
🌐 www.dumarent.be



**Bobcat®**

## OPERATING INSTRUCTIONS

INSTRUMENT PANEL IDENTIFICATION .....	31
Left And Right Panels .....	31
Standard Key Panel .....	32
Keyless Start Panel .....	32
Option And Field Accessory Panel .....	33
Cab Heater Panel .....	33
CONTROL IDENTIFICATION .....	34
Standard Controls .....	34
SEAT BAR RESTRAINT SYSTEM .....	35
Operation .....	35
BOBCAT INTERLOCK CONTROL SYSTEM (BICS™) .....	36
Operation .....	36
LIFT ARM BYPASS CONTROL .....	37
Operation .....	37
PARKING BRAKE .....	37
Operation .....	37
TRACTION LOCK OVERRIDE .....	38
Operation .....	38
EMERGENCY EXIT .....	39
Rear Window .....	39
Front Door .....	39
BACK-UP ALARM SYSTEM .....	40
Description .....	40
Operation .....	40
ENGINE SPEED CONTROL .....	41
Operation .....	41
DRIVING AND STEERING THE LOADER .....	42
Operation .....	42
STOPPING THE LOADER .....	42
Using The Control Levers .....	42
HYDRAULIC CONTROLS .....	43
Description .....	43
Hydraulic Bucket Positioning .....	43
Auxiliary Hydraulic Control Lockout .....	43
Front Auxiliary Hydraulics Operation .....	44
Quick Couplers .....	45
Relieve Auxiliary Hydraulic Pressure (Loader And Attachment) .....	45

**d** **Torkonjestraat 23**  
**8510 Marke**  
**Belgium**



**056 / 222 111**



**rental@dumarent.be**



**www.dumarent.be**

ATTACHMENT CONTROL DEVICE (ACD) .....	46
Description .....	46
DAILY INSPECTION .....	47
Daily Inspection And Maintenance .....	48
PRE-STARTING PROCEDURE .....	49
Entering The Loader .....	49
Operation & Maintenance Manual And Operator's Handbook Locations .....	49
Seat Adjustment .....	50
Seat Belt Adjustment .....	51
Seat Bar .....	51
STARTING THE ENGINE .....	52
Standard Key Panel .....	52
Keyless Start Panel .....	54
Cold Temperature Starting .....	56
Warming The Hydraulic / Hydrostatic System .....	56
MONITORING THE DISPLAY PANELS .....	56
Right Panel .....	56
STOPPING THE ENGINE AND LEAVING THE LOADER .....	57
Procedure .....	57
ATTACHMENTS .....	58
Choosing The Correct Bucket .....	58
Pallet Forks .....	58
Installing And Removing The Attachment .....	59
OPERATING PROCEDURE .....	62
Inspect The Work Area .....	62
Basic Operating Instructions .....	62
Driving On Public Roads .....	62
Operating With A Full Bucket .....	63
Operating With An Empty Bucket .....	63
Filling And Emptying The Bucket .....	64
Leveling The Ground Using Float .....	65
Digging And Filling A Hole .....	65
TOWING THE LOADER .....	66
Procedure .....	66
LIFTING THE LOADER .....	67
Single-Point Lift .....	67
TRANSPORTING THE LOADER ON A TRAILER .....	67
Loading And Unloading .....	67
Fastening .....	68



## INSTRUMENT PANEL IDENTIFICATION

### Left And Right Panels

Figure 6

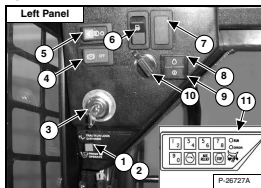
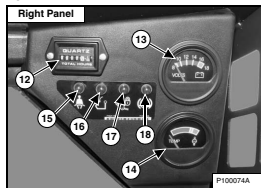

Figure 7



The table below shows the DESCRIPTION and FUNCTION / OPERATION for each of the instrument panel components.

REF.	DESCRIPTION	FUNCTION / OPERATION
1	TRACTION LOCK OVERRIDE BUTTON	<i>(Functions Only When The Seat Bar Is Raised, the Parking Brake Switch is OFF and the Engine Is Running.)</i> Allows you to use the steering levers to move the loader forward or backward when using the backhoe attachment. (See TRACTION LOCK OVERRIDE in this manual.) Engages auxiliary hydraulics.
2	PRESS TO OPERATE LOADER BUTTON	<i>(Functions Only When The Seat Bar Is Down.)</i> Activates BICS™ when the Seat Bar is down and operator is seated in the operating position. Engages auxiliary hydraulics.
3	KEY SWITCH	For starting and stopping the engine. (See Standard Key Panel in this manual.)
4	PARKING BRAKE	Press the left side of switch to engage; press right side to disengage.
5	LIGHT SWITCH	For FRONT work lights, "red" rear light, and REAR work light: Press the switch fully to the right to turn all lights OFF. Press the switch to the centre position to turn on the FRONT work lights and "red" rear light. Press the switch fully to the left to turn on the FRONT work lights and REAR work light.
6	PREHEAT SWITCH	Press and hold to preheat the glow plugs to aid in cold temperature starting. (Earlier Models)
7	NOT USED	---
8	ENGINE WARNING LIGHT	Light is ON when engine oil pressure is low or coolant temperature is high. Stop the engine if the light comes ON.
9	TRANSMISSION WARNING LIGHT	Light is ON when transmission charge pressure is low, hydraulic filter needs replacement or fluid temperature is high. Stop the engine if the light comes ON.
10	POWER PLUG	Used to power 12 volt accessories.
11	KEYLESS PANEL	Optional Keyless Panel Kit. (See Keyless Start Panel in this manual.)
12	HOURMETER	Records the total operating hours of the loader.
13	VOLTMETER	Shows the condition of the battery and the rate of charge.
14	ENGINE TEMPERATURE GAUGE	Shows the engine coolant temperature.
15	SEAT BELT INDICATOR LIGHT	Light stays on for 45 seconds to remind operator to fasten seat belt.
16	SEAT BAR LIGHT	Light is ON when the seat bar is raised.
17	LIFT & TILT VALVE LIGHT	Light is ON when the lift and tilt functions can NOT be operated. Light is OFF when the seat bar is down, the key switch is in the ON position and the PRESS TO OPERATE LOADER Button is pressed. The lift and tilt functions can be operated when the light is OFF.
18	PARKING BRAKE LIGHT	Light is ON when the Parking Brake is engaged.

## INSTRUMENT PANEL IDENTIFICATION (CONT'D)

### Standard Key Panel

Figure 8

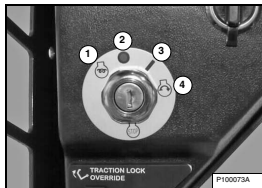

The functions of the key switch [Figure 8] are:

- ENGINE PREHEAT:** Hold the key in this position to activate the glow plugs. (Earlier model loaders have a separate preheat switch and do not have this position.) (See Left And Right Panels on Page 31.)
- STOP:** Stop the engine and turn the loader electrical system OFF.
- RUN:** Turn the loader electrical system ON.
- START:** Hold the key in this position to start the engine; release when engine starts.

### Keyless Start Panel

Figure 9

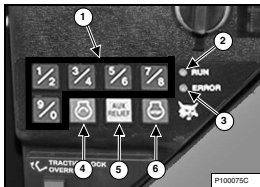

The functions of the Keyless Start Panel [Figure 9] are:

- KEYPAD (Keys 1 through 0):** Used to enter a number code (password) to allow starting the engine.
- RUN LIGHT:** Light will be ON after the password has been correctly entered.
- ERROR LIGHT:** Light will be ON when an incorrect user / master password is entered. Three consecutive incorrect passwords will cause an error condition and a delay of one minute will be required before another start sequence can be attempted.
- START Button:** Press the start button until the engine starts.
- AUX. RELIEF / PREHEAT Button:** Press and hold to activate the glow plugs after the password has been entered.
- STOP Button:** Used to stop the engine and shut down the loader electrical system.

**NOTE:** When a Keyless Start Panel Kit is installed, the kit will be supplied with an Owner Password. Change the password to one that you will easily remember to prevent unauthorised use of your loader. Keep your password in a safe place for future needs. (The instructions included with the Keyless Start Panel will describe how to change the password. Keep this instruction for future reference.)

#### INSTRUMENT PANEL IDENTIFICATION (CONT'D)

##### Option And Field Accessory Panel

Figure 10

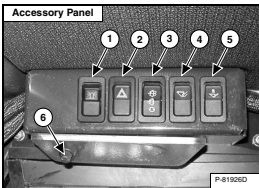

The side accessory panel is shown in [Figure 10].

REF. NO.	DESCRIPTION	FUNCTION / OPERATION
1	ROTATING BEACON (Option) <b>OR</b> STROBE LIGHT (Option)	Press the top of the switch to turn ON; press bottom to turn OFF.
2	HAZARD LIGHTS (Option)	Press the top of the switch to turn the Hazard Lights ON; press bottom to turn OFF.
3	FRONT WINDSHIELD WIPER (Option)	Move the switch to the centre position to turn ON; press bottom to turn OFF. Press and hold the top of switch for washer fluid.
4	HYDRAULIC BUCKET POSITIONING (Option)	The Bucket Positioning function will keep the bucket in approximately the same position as the lift arms are raised. Press the top of the switch to engage the Bucket Position function; press the bottom to disengage.
5	TRAVEL LOCK	Press the top of the switch to lock the lift and tilt hydraulic functions for travel. Press the bottom of the switch to turn travel lock OFF.
6	CAB LIGHT	Press the switch to turn ON, press again to turn OFF.

#### Cab Heater Panel

This machine may be equipped with a Cab Heater.

Figure 11

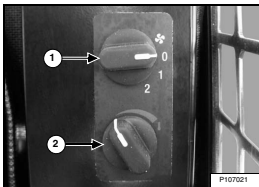

The cab heater panel is shown in [Figure 11].

REF. NO.	DESCRIPTION	FUNCTION / OPERATION
1	FAN MOTOR (Option)	Turn clockwise to increase fan speed; anticlockwise to decrease. There are three positions; OFF-1-2.
2	TEMPERATURE CONTROL (Option)	Turn clockwise to increase the temperature; anticlockwise to decrease.

**CONTROL IDENTIFICATION**

**Standard Controls**

**Figure 12**

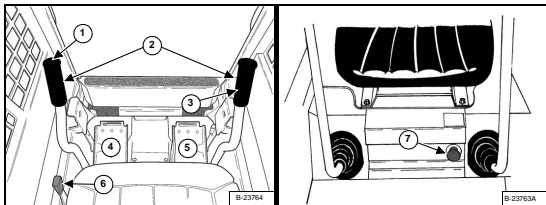

REF. NO.	DESCRIPTION	FUNCTION / OPERATION
* 1	FRONT HORN	Press the button to sound the front horn.
2	STEERING LEVERS	See DRIVING AND STEERING THE LOADER in this manual.
3	AUXILIARY HYDRAULICS CONTROL	See HYDRAULIC CONTROLS in this manual.
4	LIFT ARM PEDAL	See HYDRAULIC CONTROLS in this manual.
5	TILT PEDAL	See HYDRAULIC CONTROLS in this manual.
6	ENGINE SPEED CONTROL	See ENGINE SPEED CONTROL in this manual.
7	LIFT ARM BYPASS CONTROL	See LIFT ARM BYPASS CONTROL in this manual.

\* Press the front switch to sound the front horn if equipped with deluxe hand grips.

#### SEAT BAR RESTRAINT SYSTEM

##### Operation

Figure 13



The seat bar restraint system has a pivoting seat bar with armrests (Item 1) [Figure 13].



#### AVOID INJURY OR DEATH

##### When operating the machine:

- Keep the seat belt fastened snugly.
- The seat bar must be lowered.
- Keep your feet on the pedal controls and hands on steering levers.

W-2046-0108

The operator controls the use of the seat bar. The seat bar in the down position helps to keep the operator in the seat.

When the seat bar is down, the PRESS TO OPERATE LOADER button is activated, and the parking brake is released, the lift, tilt and traction drive functions can be operated.

When the seat bar is up, the lift, tilt and traction drive functions are deactivated. Both foot pedals will be locked when returned to the neutral position.



##### Before you leave the operator's seat:

- Lower the lift arms, put the attachment flat on the ground.
- Stop the engine.
- Engage the parking brake.
- Raise the seat bar, move pedals until both lock.
- Move auxiliary hydraulic control lever out of detent position.

W-2164-0108

**BOBCAT INTERLOCK CONTROL SYSTEM (BICS™)**

**Operation**



**AVOID INJURY OR DEATH**

The Bobcat Interlock Control System (BICS™) must deactivate the lift, tilt and traction drive functions. If it does not, contact your dealer for service. **DO NOT** modify the system.

W-2151-1111

**Figure 14**



The Bobcat Interlock Control System (BICS™) has a pivoting seat bar with armrests (Item 1) [Figure 14]. The operator controls the use of the seat bar.

The BICS™ requires the operator to be seated in the operating position with the seat bar fully lowered before the lift, tilt, auxiliary hydraulics and traction functions can be operated. The seat belt must be fastened any time you operate the machine.



**AVOID INJURY OR DEATH**

**When operating the machine:**

- Keep the seat belt fastened snugly.
- The seat bar must be lowered.
- Keep your feet on the pedal controls and hands on steering levers.

W-2046-0108

**Figure 15**

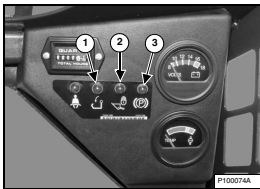

There are three display lights (Items 1, 2 and 3) [Figure 15] located on the right instrument panel that must be OFF to fully operate the machine.

When the seat bar is lowered, the engine is running, the PRESS TO OPERATE LOADER button is activated, and the parking brake is released, the lift, tilt, auxiliary hydraulics and traction drive functions can be operated.

When the seat bar is raised, the lift, tilt, auxiliary hydraulics and traction drive functions are deactivated.



**Before you leave the operator's seat:**

- Lower the lift arms, put the attachment flat on the ground.
- Stop the engine.
- Engage the parking brake.
- Raise the seat bar, move pedals until both lock.
- Move auxiliary hydraulic control lever out of detent position.

W-2164-0108

#### LIFT ARM BYPASS CONTROL

##### Operation

Figure 16

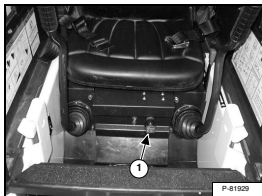

The lift arm bypass control (Item 1) [Figure 16] is used to lower the lift arms if the lift arms cannot be lowered during normal operations.

1. Sit in the operator seat.
2. Fasten the seat belt and lower the seat bar.
3. Turn the lift arm bypass knob (Item 1) [Figure 16] clockwise 1/4 turn.
4. Pull out and hold the knob until the lift arms lower.

#### PARKING BRAKE

##### Operation

Figure 17



Press the left side of the switch (Item 1) [Figure 17] to engage the parking brake. The red light in the switch will turn on. The traction drive system will be locked.

Press the right side of the switch (Item 1) [Figure 17] to disengage the parking brake. The red light in the switch will turn off. The traction drive system will be unlocked.

**NOTE:** If the loader will not move when operator is in the operating position with the seat bar down and the parking brake disengaged and after the PRESS TO OPERATE LOADER button is pressed, move the steering levers either forward or backward a small amount to unlock the traction drive.

Figure 18



**NOTE:** The PARKING BRAKE LIGHT (Item 1) [Figure 18] on the right instrument panel will remain ON until the engine is started, the PRESS TO OPERATE LOADER button is pressed and the parking brake is disengaged.

### TRACTION LOCK OVERRIDE

#### Operation

Figure 19



Figure 20



(Functions only when the seat bar is raised, the parking brake switch is OFF, and the engine is running.) There is a TRACTION LOCK OVERRIDE button (Item 1) [Figure 19] on the left instrument panel which will allow you to use the steering levers to move the loader forward and backward when using the backhoe attachment.

- Press the TRACTION LOCK OVERRIDE button once to unlock the brakes. The PARKING BRAKE light (Item 1) [Figure 20] will be OFF.
- Press the button a second time to lock the traction drive. The PARKING BRAKE light (Item 1) [Figure 20] will be ON.



#### EMERGENCY EXIT

The front opening on the operator cab and rear window provide exits.

#### Rear Window

Figure 21



Pull the tag on the top of the rear window [Figure 21] to remove the rubber cord.

Push the rear window out of the rear of the operator cab.

Figure 22



Exit through the rear of the operator cab [Figure 22].

#### Front Door

This machine may be equipped with a Front Door.

**NOTE:** When an Operator Cab Enclosure Kit is installed, the window of the front door can be used as an emergency exit [Figure 23].

**NOTE:** If the loader has a Special Application Door Kit installed, the window of the front door is NOT an emergency exit.

Figure 23

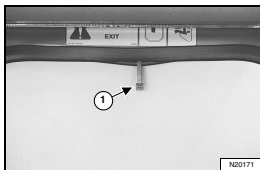

Pull the plastic loop (Item 1) [Figure 23] at the top of the window in the front door to remove the rubber cord.

Figure 24

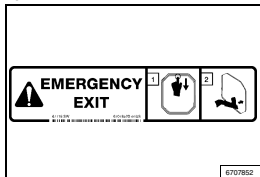

Push the window out with your foot at any corner of the window (Item 1) [Figure 24].

Exit through the front door.

#### BACK-UP ALARM SYSTEM

This machine may be equipped with a Back-Up Alarm.

#### Description

Figure 25

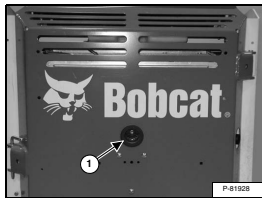

The back-up alarm (Item 1) [Figure 25] is located on the inside of the rear door.

**A back-up alarm is not a substitute for looking to the rear when operating the loader in reverse, or for keeping bystanders away from the work area. Operators must always look in the direction of travel, including reverse, and must keep bystanders away from the work area, even though the loader is equipped with a back-up alarm.**

Operators must be trained to **always** look in the direction of travel, **including when operating the loader in reverse** and to keep bystanders away from the work area. Other workers should be trained to **always** keep away from the operator's work area and travel path.

#### Operation

### WARNING

#### AVOID INJURY OR DEATH

- Always keep bystanders away from the work area and travel path.
- The operator must always look in the direction of travel.
- The back-up alarm must sound when operating the machine in the reverse direction.

W-2783-0409

The back-up alarm will sound when the operator moves both steering levers into the reverse position. Slight movement of the steering levers into the reverse position is required with hydrostatic transmissions, before the back-up alarm will sound.

If alarm does not sound or for adjustment instructions, see inspection and maintenance instructions for the back-up alarm system in the preventive maintenance section of this manual. (See BACK-UP ALARM SYSTEM on Page 83.)

**ENGINE SPEED CONTROL**

**Operation**

**Figure 26**

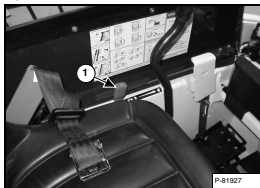

The engine speed control lever is to the left of the operator seat (Item 1) [Figure 26].

Move the lever forward to increase engine speed. Move backward to decrease engine speed.

## DRIVING AND STEERING THE LOADER

### Operation

Figure 27



The control levers (Item 1) [Figure 27] are on the left and right side in front of the seat.

Move the levers smoothly. Avoid sudden starting and stopping.

## **WARNING**

### AVOID INJURY OR DEATH

#### When operating the machine:

- Keep the seat belt fastened snugly.
- The seat bar must be lowered.
- Keep your feet on the pedal controls and hands on steering levers.

W-2046-0108

Figure 28

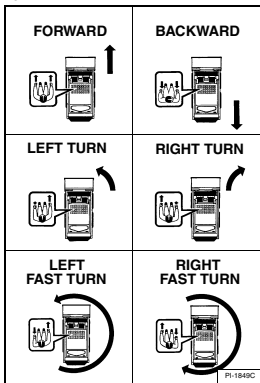

The levers control forward and backward travel and turning the loader [Figure 28].

**Forward Travel** - Push both levers forward.

**Backward Travel** - Pull both levers backward.

**Normal Turning** - Move one lever farther forward than the other.

**Fast Turning** - Push one lever forward and pull the other lever backward.

### STOPPING THE LOADER

#### Using The Control Levers

When the steering levers are moved to the neutral position, the hydrostatic transmission will act as a *service brake* to stop the loader.

## HYDRAULIC CONTROLS

### Description

Two foot pedals control the hydraulic cylinders for the lift and tilt functions.

Put your feet on the pedals and **KEEP THEM THERE** any time you operate the loader.

Figure 29

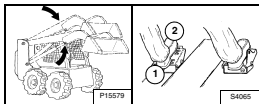

#### Lift Arm Operation (Left Pedal)

Push the heel (Item 1) [Figure 29] of the pedal to raise the lift arms.

Push the toe (Item 2) [Figure 29] of the pedal to lower the lift arms.

#### Lift Arm Float Position (Left Pedal)

Push the toe (Item 2) [Figure 29] of the pedal all the way forward until it locks into the float position.

Use the float position of the lift arms to level loose material while driving backward.

Raise the lift arms to disengage the float position.

Figure 30

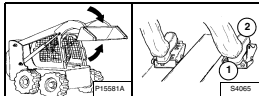

#### Tilt Operation - (Right Pedal)

Push the heel (Item 1) [Figure 30] of the pedal to tilt the bucket backward.

Push the toe (Item 2) [Figure 30] of the pedal to tilt the bucket forward.

## Hydraulic Bucket Positioning

This machine may be equipped with Hydraulic Bucket Positioning.

The function of hydraulic bucket positioning is to keep the bucket in the same approximate position it is in before you begin raising the lift arms.

Figure 31

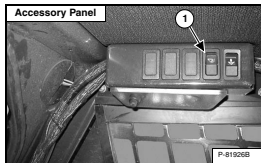

Press the top of the BUCKET POSITIONING switch (Item 1) [Figure 31] to engage the bucket positioning function. Press the bottom of the switch to disengage this function.

Bucket positioning functions only during upward lift cycle.

## Auxiliary Hydraulic Control Lockout

Figure 32

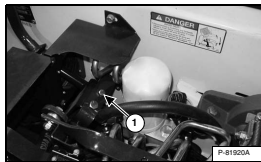

Raise the operator cab. (See OPERATOR CAB on Page 85.)

Remove the auxiliary hydraulic control lockout bolt and nut (Item 1) [Figure 32] before using the auxiliary control for the first time.

Lower the operator cab. (See OPERATOR CAB on Page 85.)

## HYDRAULIC CONTROLS (CONT'D)

### Front Auxiliary Hydraulics Operation

Figure 33

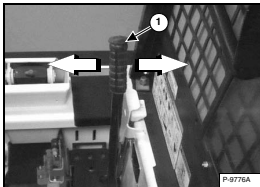

#### Variable Flow

Variable Flow allows for slow-to-fast movement of auxiliary hydraulic functions.

The right steering lever (Item 1) [Figure 33] is also the control lever for the front auxiliary hydraulics (Auxiliary Hydraulic Control Lever).

Enter the loader, lower the seat bar, fasten seat belt, engage the parking brake and start the engine. Press the PRESS TO OPERATE LOADER button which will also engage the auxiliary hydraulics.

Figure 34

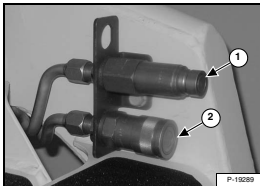

Move the Auxiliary Hydraulic Control Lever (Item 1) [Figure 33] to the left for auxiliary hydraulic oil flow to the front male coupler (Item 1) [Figure 34]. Hydraulic oil flow increases to the coupler as the lever is moved to the left.

Move the Auxiliary Hydraulic Control Lever (Item 1) [Figure 33] to the right for auxiliary hydraulic oil flow to the front female coupler (Item 2) [Figure 34]. Hydraulic oil flow increases to the coupler as the lever is moved to the right.

#### Continuous Flow

Continuous Flow allows for fast movement of auxiliary hydraulic functions.

Move the Auxiliary Hydraulic Control Lever fully to the right to put it into continuous flow (detent) position. This will allow continuous auxiliary hydraulic oil flow to the female coupler. Move the lever to the neutral position to stop auxiliary hydraulic oil flow

Move the lever out of the continuous flow (detent) position before leaving the operator's seat.

**NOTE: When the operator is seated and raises the seat bar, the Auxiliary Hydraulic System will deactivate.**

## HYDRAULIC CONTROLS (CONTD)

### Quick Couplers



## WARNING

### AVOID BURNS

Hydraulic fluid, tubes, fittings and quick couplers can get hot when running machine and attachments. Be careful when connecting and disconnecting quick couplers.

W-2220-0396



## WARNING

### AVOID INJURY OR DEATH

Diesel fuel or hydraulic fluid under pressure can penetrate skin or eyes, causing serious injury or death. Fluid leaks under pressure may not be visible. Use a piece of cardboard or wood to find leaks. Do not use your bare hand. Wear safety goggles. If fluid enters skin or eyes, get immediate medical attention from a doctor familiar with this injury.

W-2072-EN-0909

Figure 35

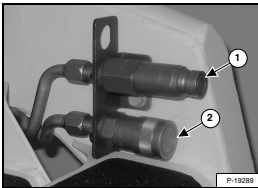

**To Connect:** Remove dirt or debris from the surface of both the male (Item 1) and female couplers (Item 2) [Figure 35], and from the outside diameter of the male coupler. Visually check the couplers for corroding, cracking, damage or excessive wear. If any of these conditions exist, the coupler(s) must be replaced.

Install the male coupler into the female coupler. Full connection is made when the ball release sleeve slides forward on the female coupler.

**To Disconnect:** Hold the male coupler. Retract the sleeve on the female coupler until the couplers disconnect.

### Relieve Auxiliary Hydraulic Pressure (Loader And Attachment)

Hydraulic pressure in the auxiliary hydraulic system can make it difficult to engage quick couplers to an attachment.

#### Loader:

1. Turn the key to the ON position or press RUN button but do not start the engine. Press the PRESS TO OPERATE LOADER Button.

Figure 36

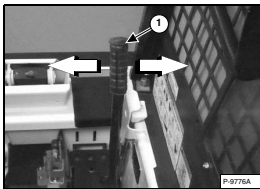

2. Move the Auxiliary Hydraulic Control Lever (Item 1) [Figure 36] left and right to release auxiliary hydraulic oil pressure. Turn key to OFF position or press STOP button.

#### Attachments:

1. Follow procedure above to release pressure in the loader.
2. Connect male coupler from attachment to female coupler of the loader then repeat procedure above. This will release pressure in the attachment.
3. Connect the female coupler from the attachment to the male coupler of the loader.

**d** Torkonjstraat 23  
8510 Marke  
Belgium

☎ 056 / 222 111  
✉ rental@dumarent.be  
🌐 www.dumarent.be

**ATTACHMENT CONTROL DEVICE (ACD)**

This machine may be equipped with an Attachment Control Device.

**Description**

**Figure 37**

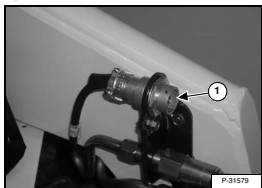

Connect the attachment electrical harness to the attachment control device (Item 1) [Figure 37].

**Figure 38**

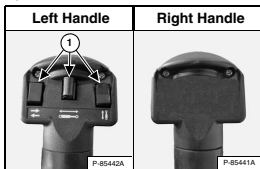

Additional switches (Item 1) [Figure 38] on the left steering lever handle are used to control some attachment functions through the attachment control device.

See the appropriate attachment Operation & Maintenance Manual for control details.





#### DAILY INSPECTION (CONTD)

##### Daily Inspection And Maintenance

Maintenance work must be done at regular intervals. Failure to do so will result in excessive wear and early failures. The Service Schedule [Figure 39] is a guide for correct maintenance of the Bobcat Loader. It is located inside the rear door of the loader.

- Engine oil level.
- Hydraulic / hydrostatic fluid level.
- Engine Air Filter - Check Air System for Damage or Leaks.
- Engine coolant system - check system for damage or leaks.
- Operator cab and cab mounting hardware.
- Seat belt.
- Seat Bar and Control interlocks.
- Bobcat Interlock Control System (BICS™).
- Front Horn - Check for proper function.
- Grease Pivot Pins (Lift Arms, Bob-Tach, Cylinders, Bob-Tach Wedges).
- Tyres - Check for Wear, Damage, Correct Air Pressure.
- Fuel Filter - Remove Trapped Water.
- Loose or Broken Parts - Repair or Replace as Necessary.
- Safety Treads and Safety Signs (Decals) - Replace as necessary.
- Lift Arm Support Device - Replace if damaged.
- Indicators and Lights.
- Clean Foot Pedal Area.
- Monitor Instrument Panel for fuel level, coolant temperature and air cleaner condition.



## WARNING

Operator must have instructions before operating the machine. Untrained operators can cause injury or death.

W-2001-0502

**NOTE:** Fluids such as engine oil, hydraulic fluid, coolant, etc. must be disposed of in an environmentally safe manner. Some regulations require that certain spills and leaks on the ground must be cleaned in a specific manner. See local bylaws for correct disposal.

## IMPORTANT

#### PRESSURE WASHING DECALS

- Never direct the stream at a low angle toward the decal that could damage the decal causing it to peel from the surface.
- Direct the stream at a 90 degree angle and at least 300 mm (12 in) from the decal. Wash from the centre of the decal toward the edges.

I-2226-EN-0910

**PRE-STARTING PROCEDURE**

**Entering The Loader**

**Figure 40**



Use the bucket or attachment steps, grab handles and safety treads (on the loader lift arms and frame) to get on and off the loader [Figure 40]. DO NOT JUMP.

Safety treads are installed on the Bobcat Loader to provide a slip resistant surface for getting on and off the loader.

Keep the safety treads clean and replace them when damaged. Replacement treads are available from your Bobcat dealer.

**Operation & Maintenance Manual And Operator's Handbook Locations**

**Figure 41**

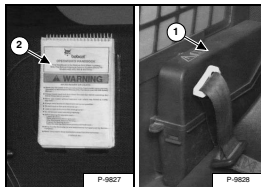

Read and understand the Operation & Maintenance Manual (Item 1) and the Operator's Handbook (Item 2) [Figure 41] before operating the loader.

The Operation & Maintenance Manual and other manuals can be kept in a container (Item 1) [Figure 41] provided on the right side of the operator seat.

**! WARNING**

**AVOID INJURY OR DEATH**

Instructions are necessary before operating or servicing machine. Read and understand the Operation & Maintenance Manual, Operator's Handbook and signs (decals) on machine. Follow warnings and instructions in the manuals when making repairs, adjustments or servicing. Check for correct function after adjustments, repairs or service. Untrained operators and failure to follow instructions can cause injury or death.

W-2003-0807

**PRE-STARTING PROCEDURE (CONT'D)**

**Seat Adjustment**

**Figure 42**

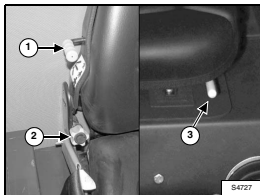

Use the lever (Item 1) and knob (Item 2) [Figure 42] to adjust the position of the seat for comfortable operation of the loader controls.

The lever (Item 1) sets the seat cushion for the weight of the operator. The knob (Item 2) [Figure 42] sets the angle of the seat back.

The lever (Item 3) [Figure 42] adjusts the fore / aft position of the seat.

**PRE-STARTING PROCEDURE (CONT'D)**

**Seat Belt Adjustment**



**AVOID INJURY OR DEATH**

When operating the machine:

- Keep the seat belt fastened snugly.
- The seat bar must be lowered.
- Keep your feet on the pedal controls and hands on steering levers.

W-2046-0108

**Figure 43**

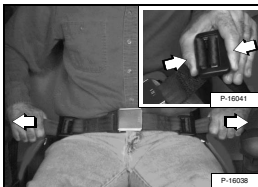

Squeeze both seat belt adjusters to release and lengthen each half of the seat belt [Figure 43].

Fasten the seat belt.

Pull the ends of the belt through the belt adjusters so that the seat belt is snug and the buckle is centred between your hips [Figure 43].

**Seat Bar**

**Figure 44**

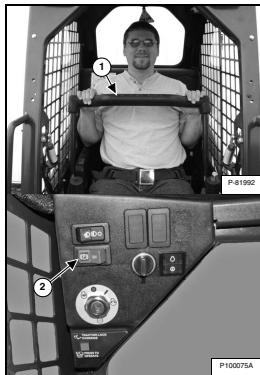

Lower the seat bar (Item 1) and engage the parking brake (Item 2) [Figure 44].

Put the foot pedals and steering levers in neutral position.

**NOTE:** Keep your hands on the steering levers and your feet on the foot pedals while operating the loader.



**AVOID INJURY OR DEATH**

When operating the machine:

- Keep the seat belt fastened snugly.
- The seat bar must be lowered.
- Keep your feet on the pedal controls and hands on steering levers.

W-2046-0108

**STARTING THE ENGINE**

**Standard Key Panel**



**WARNING**

**AVOID INJURY OR DEATH**

- Engines can have hot parts and hot exhaust gas. Keep flammable material away.
- Do not use machines in atmosphere containing explosive gas.

W-2051-1086

Perform the PRE-STARTING PROCEDURE. (See PRE-STARTING PROCEDURE on Page 49.)

**Figure 45**

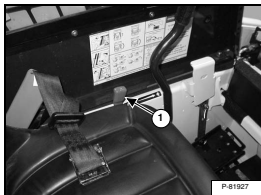

Move the engine speed control lever (Item 1) [Figure 45] to the mid position.



**WARNING**

**AVOID INJURY OR DEATH**

- Fasten seat belt, start and operate only from the operator's seat.
- Never wear loose clothing when working near machine.

W-2135-1108

**Figure 46**

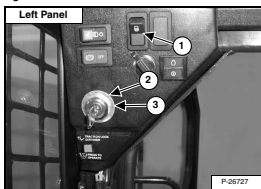

*Earlier Models With Preheat Switch (Item 1)*

If the temperature is cold, turn the key switch to the RUN position (Item 2) [Figure 46] but do not start the engine.

Press and hold the top of the preheat switch (Item 1) [Figure 46]. Release the switch to stop engine preheat. A decal in the operator cab and the table below show suggested preheat times.

AMBIENT AIR TEMPERATURE	PREHEAT TIME
21°C and Above (70°F and Above)	None Required
10 - 21°C (50 - 70°F)	5 Seconds
-18 - 10°C (0 - 50°F)	15 Seconds
-18°C and Below (0°F and Below)	25 Seconds

**NOTE: You can hold the preheat switch for up to 25 seconds at a time while cranking.**

Turn the key switch to the START position (Item 3) [Figure 46] and continue to crank for up to one minute or until the engine starts.

Release the key when the engine starts. It will return to the RUN position (Item 2) [Figure 46].

## STARTING THE ENGINE (CONT'D)

### Standard Key Panel (Cont'd)

Figure 47

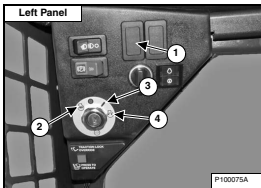

### Later Models Without Preheat Switch (Item 1)

If the temperature is cold, turn the key switch to the PREHEAT position (Item 2) [Figure 47].

Release the key switch to stop engine preheat. A decal in the operator cab and the table below show suggested preheat times.

AMBIENT AIR TEMPERATURE	PREHEAT TIME
21°C and Above (70°F and Above)	None Required
10 - 21°C (50 - 70°F)	5 Seconds
-18 - 10°C (0 - 50°F)	15 Seconds
-18°C and Below (0°F and Below)	25 Seconds

Turn the key switch to the START position (Item 4) [Figure 47] and continue to crank for up to one minute or until the engine starts.

Release the key when the engine starts. It will return to the RUN position (Item 3) [Figure 47].

### All Models

Figure 48

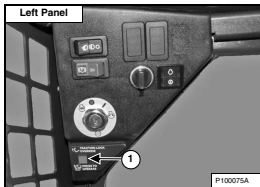
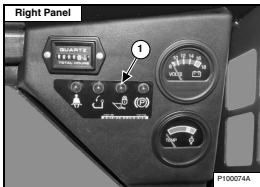

Figure 49



Press the PRESS TO OPERATE LOADER button (Item 1) [Figure 48] to activate the BICS™ and to perform hydraulic and loader functions. The Lift & Tilt Valve light (Item 1) [Figure 49] will be OFF when the BICS™ is active.

## WARNING

**AVOID INJURY OR DEATH**  
 When an engine is running in an enclosed area, fresh air must be added to avoid concentration of exhaust fumes. If the engine is stationary, vent the exhaust outside. Exhaust fumes contain odorless, invisible gases which can kill without warning.

W-2050-0807

**STARTING THE ENGINE (CONT'D)**

**Keyless Start Panel**



**WARNING**

**AVOID INJURY OR DEATH**

- Engines can have hot parts and hot exhaust gas. Keep flammable material away.
- Do not use machines in atmosphere containing explosive gas.

W-2051-1086

Perform the PRE-STARTING PROCEDURE. (See PRE-STARTING PROCEDURE on Page 49.)

**Figure 50**

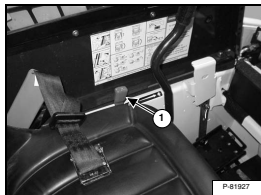

Move the engine speed control lever (Item 1) [Figure 50] to the mid position.



**WARNING**

**AVOID INJURY OR DEATH**

- Fasten seat belt, start and operate only from the operator's seat.
- Never wear loose clothing when working near machine.

W-2135-1108

**Figure 51**

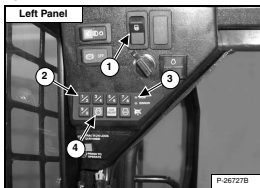

*Earlier Models With Preheat Switch (Item 1)*

Enter the password / user code on the keypad (Item 2), the RUN light (Item 3) [Figure 51] will illuminate.

If the temperature is cold, press and hold the top of the preheat switch (Item 1) [Figure 51]. Release the switch to stop engine preheat.

A decal in the operator cab and the table below show suggested preheat times.

AMBIENT AIR TEMPERATURE	PREHEAT TIME
21°C and Above (70°F and Above)	None Required
10 - 21°C (50 - 70°F)	5 Seconds
-18 - 10°C (0 - 50°F)	15 Seconds
-18°C and Below (0°F and Below)	25 Seconds

**NOTE: You can hold the preheat switch for up to 25 seconds at a time while cranking.**

Press the start button (Item 4) [Figure 51] and continue to crank for up to one minute or until the engine starts.

Release the start button when the engine starts.



**STARTING THE ENGINE (CONT'D)**

**Keyless Start Panel (Cont'd)**

**Figure 52**

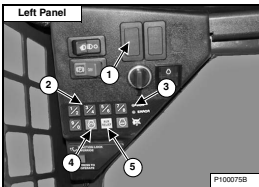

*Later Models Without Preheat Switch (Item 1)*

Enter the password / user code on the keypad (Item 2), the RUN light (Item 3) [Figure 52] will illuminate.

If the temperature is cold, press and hold the AUX. RELIEF / Preheat button (Item 5) [Figure 52]. Release the button to stop engine preheat.

A decal in the operator cab and the table below show suggested preheat times.

AMBIENT AIR TEMPERATURE	PREHEAT TIME
21°C and Above (70°F and Above)	None Required
10 - 21°C (50 - 70°F)	5 Seconds
-18 - 10°C (0 - 50°F)	15 Seconds
-18°C and Below (0°F and Below)	25 Seconds

**NOTE:** You can hold the AUX. RELIEF / Preheat button for up to 25 seconds at a time while cranking.

Press the start button (Item 4) [Figure 52] and continue to crank for up to one minute or until the engine starts.

Release the start button when the engine starts.

*All Models*

**Figure 53**

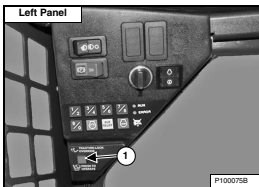

**Figure 54**

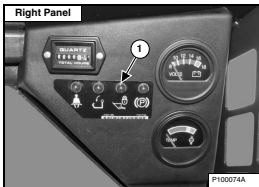

Press the PRESS TO OPERATE LOADER button (Item 1) [Figure 53] to activate the BICS™ and to perform hydraulic and loader functions. The Lift & Tilt Valve light (Item 1) [Figure 54] will be OFF when the BICS™ is active.

**⚠ WARNING**

**AVOID INJURY OR DEATH**

When an engine is running in an enclosed area, fresh air must be added to avoid concentration of exhaust fumes. If the engine is stationary, vent the exhaust outside. Exhaust fumes contain odorless, invisible gases which can kill without warning.

W-2050-0807

d Torkonjestraat 23  
8510 Marke  
Belgium



056 / 222 111



rental@dumarent.be



www.dumarent.be

#### STARTING THE ENGINE (CONT'D)

##### Cold Temperature Starting



## WARNING

#### AVOID INJURY OR DEATH

Do not use ether with glow plug (preheat) systems. Explosion can result which can cause injury, death, or severe engine damage.

W-2071-0907

If the temperature is below freezing perform the following to make starting the engine easier:

- Replace the engine oil with the correct type and viscosity for the anticipated starting temperature (See Engine Oil Chart on Page 93.)
- Make sure the battery is fully charged.
- Install an engine heater, available from your local Bobcat dealer.

##### Warming The Hydraulic / Hydrostatic System

## IMPORTANT

When the temperature is below  $-30^{\circ}\text{C}$  ( $-20^{\circ}\text{F}$ ), hydrostatic oil must be warmed before starting. The hydrostatic system will not get enough oil at low temperatures and will be damaged. Park the machine in an area where the temperature will be above  $-18^{\circ}\text{C}$  ( $0^{\circ}\text{F}$ ) if possible.

I-2007-0910

Let the engine run for a minimum of 5 minutes to warm the engine and hydrostatic transmission fluid before operating the loader.

#### MONITORING THE DISPLAY PANELS

##### Right Panel

Figure 55

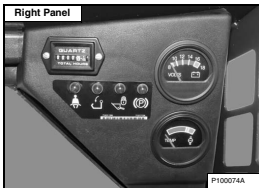

Frequently monitor the temperature gauge and BICS™ lights [Figure 55]. All BICS™ lights must be off to operate the loader. (See BOBCAT INTERLOCK CONTROL SYSTEM (BICS™) on Page 77.)

#### STOPPING THE ENGINE AND LEAVING THE LOADER

##### Procedure

Stop the Bobcat Loader on level ground.

Lower the lift arms fully and put the attachment flat on the ground.

Figure 56

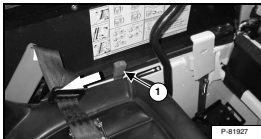

Pull the engine speed control lever (Item 1) [Figure 56] fully backward to decrease the engine speed.

Figure 57

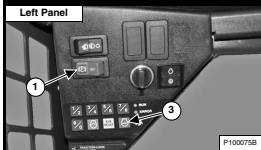
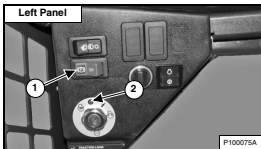

Turn the key switch to the OFF position (Item 2) or press the STOP button (Item 3) [Figure 57].

Engage the parking brake by pressing the left side of the parking brake switch (Item 1) [Figure 57].

Raise the seat bar and make sure the lift and tilt functions are deactivated. Move the pedals until they both lock.

Move auxiliary hydraulic control lever out of detent position.

Unbuckle the seat belt.

Remove the key from the switch to prevent operation of the loader by unauthorised personnel. (Standard Key Panel only.)

Figure 58



Exit the loader using grab handles, safety tread and steps (maintaining a 3-point contact) [Figure 58].

## **WARNING**

Before you leave the operator's seat:

- Lower the lift arms, put the attachment flat on the ground.
- Stop the engine.
- Engage the parking brake.
- Raise the seat bar, move pedals until both lock.
- Move auxiliary hydraulic control lever out of detent position.

W-2164-0108

**ATTACHMENTS**

**Choosing The Correct Bucket**

**⚠ WARNING**

**AVOID INJURY OR DEATH**

Never use attachments or buckets which are not approved by Bobcat Company. Buckets and attachments for safe loads of specified densities are approved for each model. Unapproved attachments can cause injury or death.

W-2052-0907

**NOTE: Warranty is void if non-approved attachments are used on the Bobcat Loader.**

The dealer can identify, for each model loader, the attachments and buckets approved by Bobcat. The buckets and attachments are approved for Rated Operating Capacity (ROC) and for secure fastening to the Bob-Tach.

The ROC for this loader is shown on a decal in the operator cab. (See Performance on Page 122.)

The ROC is determined by using a standard bucket, and material of normal density, such as dirt or dry gravel. If longer buckets are used, the load centre moves forward and reduces the ROC. If very dense material is loaded, the volume must be reduced to prevent overloading.

**Figure 59**

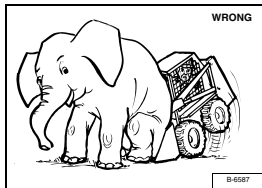

Exceeding the ROC [Figure 59] can cause the following problems:

- Steering the loader may be difficult.
- Tyres will wear faster.
- There will be a loss of stability.
- The life of the Bobcat Loader will be reduced.

Use the correct bucket size for the type and density of material being handled. For safe handling of materials and avoiding machine damage, the attachment (or bucket) should handle a full load without going over the ROC for the loader. Partial loads make steering more difficult.

**Pallet Forks**

**Figure 60**

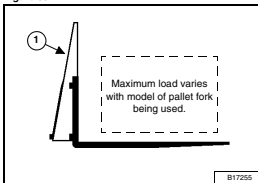

The maximum load to be carried when using a pallet fork is shown on a decal located on the pallet fork frame (Item 1) [Figure 60].

See your Bobcat dealer for more information about pallet fork inspection, maintenance and replacement. See your Bobcat Loader dealer for ROC when using a pallet fork and for other available attachments.

**⚠ WARNING**

**AVOID INJURY OR DEATH**

**Do not exceed Rated Operating Capacity (ROC). Excessive load can cause tipping or loss of control.**

W-2053-0903

**d** Torkonjestrat 23  
8510 Marke  
Belgium

☎ 056 / 222 111  
✉ rental@dumarent.be  
🌐 www.dumarent.be

#### ATTACHMENTS (CONT'D)

##### Installing And Removing The Attachment

The Bob-Tach is used for fast changing of buckets and attachments. See the appropriate attachment Operation & Maintenance Manual to install other attachments.

##### Installing

Figure 61

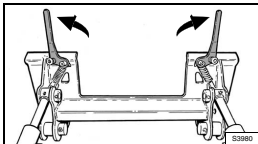

Pull the Bob-Tach levers all the way up [Figure 61].

Enter the loader and perform the PRE-STARTING PROCEDURE. (See PRE-STARTING PROCEDURE on Page 49.) Start the engine.

Lower the lift arms and tilt the Bob-Tach slightly forward.

Figure 62

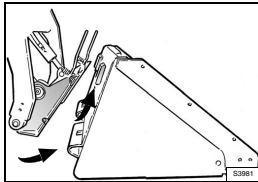

Disengage the parking brake and drive the loader forward until the top edge of the Bob-Tach is completely under the top flange of the bucket [Figure 62] (or other attachment).

NOTE: Make sure the Bob-Tach levers do not hit the bucket (or other attachment).

Figure 63

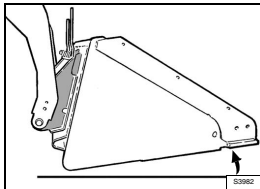

Tilt the Bob-Tach backward until the cutting edge of the bucket (or other attachment) is slightly off the ground [Figure 63]. This will cause the bucket frame to fit up against the front of the Bob-Tach.

## ⚠ WARNING

Before you leave the operator's seat:

- Lower the lift arms, put the attachment flat on the ground.
- Stop the engine.
- Engage the parking brake.
- Raise the seat bar, move pedals until both lock.
- Move auxiliary hydraulic control lever out of detent position.

W-2164-0108

Stop the engine, engage the parking brake, raise the seat bar, unfasten the seat belt and exit the loader.



056 / 222 111



rental@dumarent.be



www.dumarent.be

## ATTACHMENTS (CONTD)

### Installing And Removing The Attachment (Cont'd)

Installing (Cont'd)

Figure 64

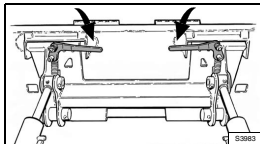

Push down on the Bob-Tach levers until they are fully engaged in the locked position [Figure 64].

Figure 65

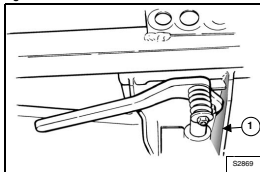

The levers must contact the frame at the shaded areas (Item 1) [Figure 65] (wedges fully extended).

If the levers do not engage in the locked position, contact your Bobcat dealer for maintenance.

Figure 66



The wedges must extend through the holes in the mounting frame of the bucket (or attachment) and touch the lower edge of these holes, securely fastening the bucket to the Bob-Tach [Figure 66].



**WARNING**

#### AVOID INJURY OR DEATH

The Bob-Tach wedges must extend through the holes in the attachment mounting frame. Levers must be fully down and locked. Failure to secure wedges can allow attachment to come off.

W-2715-0208

If the attachment is hydraulically controlled, connect the hydraulic hoses of the attachment to the loader (See Quick Couplers on Page 45.) You may need to release hydraulic pressure before connecting the quick couplers. (See Relieve Auxiliary Hydraulic Pressure (Loader And Attachment) on Page 45.)

**d** **Torkonjestraat 23**  
**8510 Marke**  
**Belgium**



**056 / 222 111**



**rental@dumarent.be**



**www.dumarent.be**

**ATTACHMENTS (CONTD)**

**Installing And Removing The Attachment (Cont'd)**

*Removing*

- Lower the lift arms, put the attachment flat on the ground and lower or close the hydraulic equipment.
- If the attachment is hydraulically controlled (Combination bucket, backhoe, etc.): stop the engine and relieve hydraulic pressure in the auxiliary circuit (See *Relieve Auxiliary Hydraulic Pressure (Loader And Attachment)* on Page 45.)
- Stop the engine, engage the parking brake, raise the seat bar, unfasten the seat belt and exit the loader.
- Disconnect the hydraulic hoses from the attachment.



**Before you leave the operator's seat:**

- Lower the lift arms, put the attachment flat on the ground.
- Stop the engine.
- Engage the parking brake.
- Raise the seat bar, move pedals until both lock.
- Move auxiliary hydraulic control lever out of detent position.

W-2164-0108

Enter the loader and perform the **PRE-STARTING PROCEDURE**. (See **PRE-STARTING PROCEDURE** on Page 49.) Start the engine and disengage the parking brake.

**Figure 68**

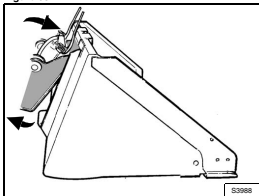

Tilt the Bob-Tach forward while backing the loader away from the bucket or attachment [Figure 68].

**NOTE:** In muddy conditions or to prevent the attachment from freezing to the ground, put the attachment on planks or blocks before removing it from the machine.

**Figure 67**

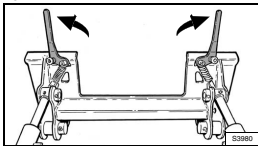

Pull the Bob-Tach levers all the way up [Figure 67].



Bob-Tach levers have spring tension. Hold lever tightly and release slowly. Failure to obey warning can cause injury.

W-2054-1285

## OPERATING PROCEDURE

### Inspect The Work Area

Before beginning operation, inspect the work area for unsafe conditions.

Look for sharp drop-offs or rough terrain. Have underground utility lines (gas, electrical, water, sewer, irrigation, etc.) located and marked.

Remove objects or other construction material that could damage the loader or cause personal injury.

Always check ground conditions before starting your work:

- Inspect for signs of instability such as cracks or settlement.
- Be aware of weather conditions that can affect ground stability.
- Check for adequate traction if working on a slope.

### Basic Operating Instructions

Always warm the engine and hydrostatic system before operating the loader.

## IMPORTANT

**Machines warmed up with moderate engine speed and light load have longer life.**

I-2015-0284

Operate the loader with engine at full speed for maximum horsepower. Move the steering levers only a small amount to operate the loader slowly.

New operators must operate the loader in an open area without bystanders. Operate the controls until the loader can be handled at an efficient and safe rate for all conditions of the work area.

### Operating Near An Edge Or Water

Keep the loader as far back from the edge as possible and the loader wheels perpendicular to the edge so that if part of the edge collapses, the loader can be moved back.

Always move the loader back at any indication the edge may be unstable.



## WARNING

### MACHINE TIPPING OR ROLL OVER CAN CAUSE SERIOUS INJURY OR DEATH

- Keep the lift arms as low as possible.
- Do not travel or turn with the lift arms up.
- Turn on level ground. Slow down when turning.
- Go up and down slopes, not across them.
- Keep the heavy end of the machine uphill.
- Do not overload the machine.
- Check for adequate traction.

W-2018-1109

### Driving On Public Roads

When operating on a public road or motorway, always follow local regulations. For example: Slow Moving Vehicle Sign or direction signals may be required.

**NOTE:** Road Option kits are available from your Bobcat dealer to equip your machine for driving on public roads in European Union (EU) countries.

**Always follow local regulations. For more information, contact your local Bobcat dealer.**



OPERATING PROCEDURE (CONT'D)

Operating With A Full Bucket

Figure 69

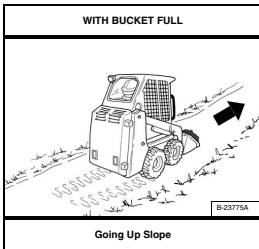
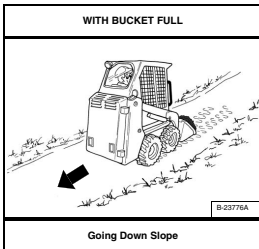

Figure 70



With a full bucket, go up or down the slope with the bucket (heavy end) toward the top of the slope [Figure 69] and [Figure 70].

Operating With An Empty Bucket

Figure 71

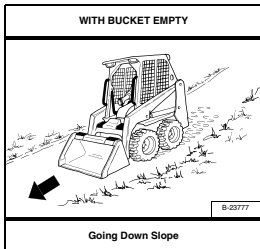
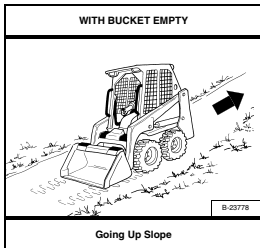

Figure 72



With an empty bucket, go up or down the slope with the back of the loader (heavy end) toward the top of the slope [Figure 71] and [Figure 72].

Raise the bucket only high enough to avoid obstructions on rough ground.

**OPERATING PROCEDURE (CONT'D)**

**Filling And Emptying The Bucket**

*Filling*

**Figure 73**

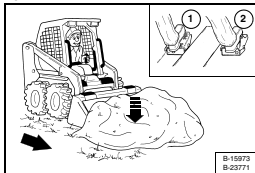

**Figure 74**

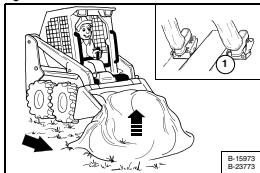

Lower the lift arms all the way by pushing the toe of the left pedal (Item 1) [Figure 73]. Tilt the bucket forward by pushing the toe of the right pedal (Item 2) [Figure 73] until the cutting edge of the bucket is on the ground.

Drive slowly forward into the material. Tilt the bucket backward all the way by pushing the heel of the right pedal (Item 1) [Figure 74] when the bucket is full.

Drive backward away from the material.



**WARNING**  
 Load, unload and turn on flat level ground. Do not exceed Rated Operating Capacity (ROC) shown on sign (decals) in cab. Failure to obey warnings can cause the machine to tip or roll over and cause injury or death.

W-2056-0903

*Emptying*

**Figure 75**

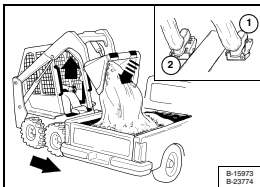

Keep the bucket low when moving to the area where you want to empty the bucket.

Level the bucket by pushing the toe of the right pedal (Item 1) while raising the lift arms to help prevent material from falling off the back of the bucket. Raise the lift arms by pushing the heel of the left pedal (Item 2) [Figure 75].

Drive forward slowly until the bucket is over the top of the truck box or bin [Figure 75].

Empty the bucket by pushing the toe of the right pedal (Item 1) [Figure 75]. If all the material is near the side of the truck or bin, use the bucket tilt to move it to the other side.



**WARNING**  
 Never dump over an obstruction, such as a post, that can enter the operator cab. The machine could tip forward and cause injury or death.

W-2057-0694

**OPERATING PROCEDURE (CONT'D)**

**Leveling The Ground Using Float**

**Figure 76**

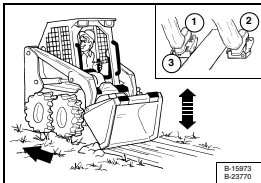

Put the lift arms in *float* position by pushing the toe of the left pedal (Item 1) [Figure 76] until it is locked in the forward position.

Tilt the bucket forward by pushing the toe of the right pedal (Item 2) [Figure 76] to change the position of the cutting edge of the bucket.

With the bucket tilted farther forward, there is more force on the cutting edge and more loose material can be moved.

Drive backward to level loose material [Figure 76].

Push the heel of the left pedal (Item 3) [Figure 76] to unlock the float position.

**IMPORTANT**

**Never drive forward when the hydraulic control for lift arms is in float position.**

I-2005-1285

**Digging And Filling A Hole**

*Digging*

**Figure 77**

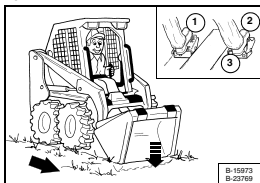

Lower the lift arms all the way by pushing the toe of the left pedal (Item 1) [Figure 77]. Put the cutting edge of the bucket on the ground by pushing the toe of the right pedal (Item 2) [Figure 77].

Drive forward slowly and continue to tilt the bucket down (Item 2) [Figure 77] until it enters the ground.

Raise the cutting edge a small amount by pushing the heel of the right pedal (Item 3) [Figure 77] to increase traction and keep an even digging depth. Continue to drive forward until the bucket is full. When the ground is hard, raise and lower the cutting edge of the bucket (Items 2 and 3) [Figure 77] while driving forward slowly.

**Figure 78**

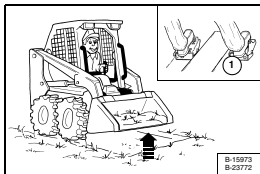

Tilt the bucket backward by pushing the heel of the right pedal (Item 1) [Figure 78] as far as it will go when the bucket is full.

## OPERATING PROCEDURE (CONT'D)

### Digging And Filling (Cont'd)

#### Filling

Figure 79

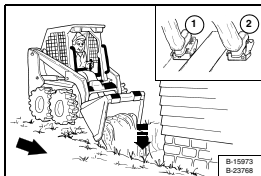

Lower the lift arms by pushing the toe of the left pedal (Item 1) [Figure 79]. Put the cutting edge of the bucket on the ground by pushing the toe of the right pedal (Item 2) [Figure 79]. Drive forward to the edge of the hole to push the material into the hole.

Tilt the bucket farther forward (Item 2) [Figure 79] as soon as it is past the edge of the hole.

If necessary, raise the lift arms to empty the bucket.

## TOWING THE LOADER

### Procedure

Because of the design of the loader, there is not a recommended towing procedure.

- The loader can be lifted onto a transport vehicle.
- The loader can be skidded a short distance to move for service (EXAMPLE: Move onto a transport vehicle.) without damage to the hydrostatic system. (The wheels will not turn.) There might be slight wear to the tyres when the loader is skidded.

The towing chain (or cable) must be rated at 1.5 times the weight of the loader. (See Performance on Page 122.)

#### LIFTING THE LOADER

##### Single-Point Lift

### WARNING

#### AVOID INJURY OR DEATH

- Before lifting, check fasteners on single point lift and operator cab.
- Assemble front cab fasteners as shown in this manual.
- Never allow riders in the cab or bystanders within 5 m (15 ft) while lifting the machine.

W-2007-0910

The loader can be lifted with the Single-Point Lift which is available as a kit from your Bobcat Loader dealer.

The Single-Point Lift, supplied by Bobcat, is designed to lift and support the Bobcat Loader without affecting roll over and falling object protection features of the operator cab.

Figure 80

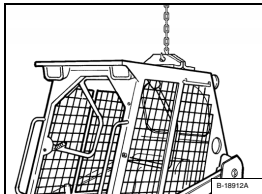

Attach lift to lift eye [Figure 80].

**NOTE:** Be sure the lifting equipment is of adequate size and capacity for the weight of the loader. (See Performance on Page 122.)

#### TRANSPORTING THE LOADER ON A TRAILER

##### Loading And Unloading

### WARNING

#### AVOID SERIOUS INJURY OR DEATH

Adequately designed ramps of sufficient strength are needed to support the weight of the machine when loading onto a transport vehicle. Wood ramps can break and cause personal injury.

W-2058-0807

Be sure the transport and towing vehicles are of adequate size and capacity for the weight of the loader. (See Performance on Page 122.)

Figure 81

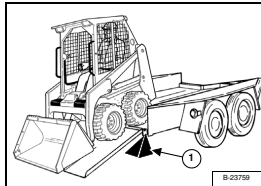

A loader with an empty bucket or no attachment must be loaded backward onto the transport vehicle [Figure 81].

The rear of the trailer must be blocked or supported (Item 1) [Figure 81] when loading or unloading the loader to prevent the front end of the trailer from raising up.



#### TRANSPORTING THE LOADER ON A TRAILER (CONT'D)

##### Fastening

Figure 82

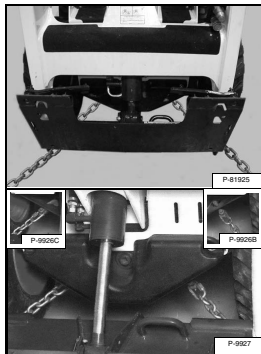

Use the following procedure to fasten the Bobcat Loader to the transport vehicle to prevent the loader from moving during sudden stops or when going up or down slopes [Figure 82].

- Lower the bucket or attachment to the floor.
- Stop the engine.
- Engage the parking brake.
- Install chains at the front tie down positions [Figure 82].
- Fasten each end of the chain to the transport vehicle.

Figure 83

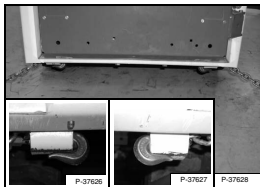

- Install chains at the rear tie down positions [Figure 83].
- Fasten each end of the chain to the transport vehicle.

**d** **Torkonjstraat 23**  
**8510 Marke**  
**Belgium**



**056 / 222 111**



**rental@dumarent.be**



**www.dumarent.be**

## PREVENTIVE MAINTENANCE

MAINTENANCE SAFETY .....	73
SERVICE SCHEDULE .....	75
Chart .....	75
Inspection Checkbook .....	76
BOBCAT INTERLOCK CONTROL SYSTEM (BICST <sup>™</sup> ) .....	77
Inspecting The BICST <sup>™</sup> (Engine STOPPED - Key ON) .....	77
Inspecting The Seat Bar Sensor (Engine RUNNING) .....	77
Inspecting The Traction Lock (Engine RUNNING) .....	77
Inspecting The Lift Arm Bypass Control .....	77
Inspecting Deactivation Of The Auxiliary Hydraulics System .....	78
SEAT BAR RESTRAINT SYSTEM .....	79
Description .....	79
Inspecting .....	79
Maintaining .....	79
SEAT BELT .....	80
Inspection And Maintenance .....	80
LIFT ARM SUPPORT DEVICE .....	81
Installing .....	81
Removing .....	82
BACK-UP ALARM SYSTEM .....	83
Description .....	83
Inspecting .....	83
Adjusting Switch Position .....	84
OPERATOR CAB .....	85
Description .....	85
Raising .....	85
Lowering .....	86
REAR DOOR (TAILGATE) .....	88
Opening And Closing .....	88
AIR CLEANER SERVICE .....	89
Replacing Filter Elements .....	89
FUEL SYSTEM .....	90
Fuel Specifications .....	90
Biodiesel Blend Fuel .....	90
Filling The Fuel Tank .....	91
Fuel Filter .....	92
Removing Air From The Fuel System .....	92

ENGINE LUBRICATION SYSTEM .....	93
Checking And Adding Engine Oil .....	93
Engine Oil Chart .....	93
Removing And Replacing Oil And Filter .....	93
ENGINE COOLING SYSTEM .....	94
Cleaning .....	94
Checking Level .....	94
Removing And Replacing Coolant .....	95
ELECTRICAL SYSTEM .....	96
Description .....	96
Fuse And Relay Location / Identification .....	96
Battery Maintenance .....	97
Using A Booster Battery (Jump Starting) .....	97
Removing And Installing Battery .....	99
HYDRAULIC / HYDROSTATIC SYSTEM .....	100
Checking And Adding Fluid .....	100
Hydraulic / Hydrostatic Fluid Chart .....	100
Removing And Replacing Hydraulic Fluid .....	101
Removing And Replacing Hydraulic / Hydrostatic Filter .....	102
Breather Cap .....	102
SPARK ARRESTER MUFFLER .....	103
Cleaning Procedure .....	103
TYRE MAINTENANCE .....	104
Wheel Nuts .....	104
Rotating .....	104
Mounting .....	104
FINAL DRIVE TRANSMISSION (CHAINCASE) .....	105
Checking And Adding Oil .....	105
Removing And Replacing Oil .....	105
ALTERNATOR BELT .....	106
Belt Adjustment .....	106
Belt Replacement .....	106
DRIVE BELT .....	107
Belt Adjustment .....	107
Belt Replacement .....	107
LUBRICATING THE LOADER .....	108
Lubrication Locations .....	108
PIVOT PINS .....	110
Inspection And Maintenance .....	110
BOB-TACH .....	111
Inspection And Maintenance .....	111





**\*Always follow manufacturer instructions\***



Torkonjestraat 23  
8510 Marke  
Belgium



056 / 222 111



rental@dumarent.be



www.dumarent.be

LOADER STORAGE AND RETURN TO SERVICE .....	112
Storage .....	112
Return To Service .....	112



**\* Always follow manufacturer instructions \***

**d** Torkonjstraat 23  
8510 Marke  
Belgium



056 / 222 111



rental@dumarent.be



www.dumarent.be



**Bobcat®**

## MAINTENANCE SAFETY

### ⚠ WARNING

Instructions are necessary before operating or servicing machine. Read and understand the Operation & Maintenance Manual, Operator's Handbook and signs (decals) on machine. Follow warnings and instructions in the manuals when making repairs, adjustments or servicing. Check for correct function after adjustments, repairs or service. Untrained operators and failure to follow instructions can cause injury or death.

W-2003-0807



**Safety Alert Symbol:** This symbol with a warning statement, means: "Warning, be alert! Your safety is involved!" Carefully read the message that follows.

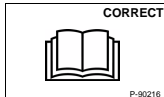

- ⚠ Never service the Bobcat Skid-Steer Loader without instructions.

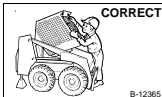

- ⚠ Use the correct procedure to lift or lower operator cab.

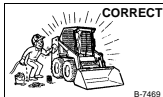

- ⚠ Cleaning and maintenance are required daily.



- ⚠ Have good ventilation when welding or grinding painted parts.
- ⚠ Wear dust mask when grinding painted parts. Toxic dust and gas can be produced.
- ⚠ Avoid exhaust fume leaks which can kill without warning. Exhaust system must be tightly sealed.

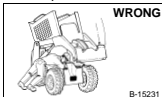

- ⚠ Disconnecting or loosening any hydraulic tubing, hose, fitting, component or a part failure can cause lift arms to drop. Do not go under lift arms when raised unless supported by an approved lift arm support device. Replace it if damaged.



- ⚠ Never work on loader with lift arms up unless lift arms are held by an approved lift arm support device. Replace if damaged.
- ⚠ Never modify equipment or add attachments not approved by Bobcat Company.



- ⚠ Stop, cool and clean engine of flammable materials before checking fluids.
- ⚠ Never service or adjust loader with the engine running unless instructed to do so in the manual.
- ⚠ Avoid contact with leaking hydraulic fluid or diesel fuel under pressure. It can penetrate the skin or eyes.
- ⚠ Never fill fuel tank with engine running, while smoking or when near open flame.



- ⚠ Keep body, jewelry and clothing away from moving parts, electrical contact, hot parts and exhaust.
- ⚠ Wear eye protection to guard from battery acid, compressed springs, fluids under pressure and flying debris when engines are running or tools are used. Use eye protection approved for type of welding.
- ⚠ Keep rear door closed except for service. Close and latch door before operating the loader.



- ⚠ Lead-acid batteries produce flammable and explosive gases.
- ⚠ Keep arcs, sparks, flames and lighted tobacco away from batteries.
- ⚠ Batteries contain acid which burns eyes or skin on contact. Wear protective clothing. If acid contacts body, flush well with water. For eye contact flush well and get immediate medical attention.

Maintenance procedures which are given in the Operation & Maintenance Manual can be performed by the owner/operator without any specific technical training. Maintenance procedures which are not in the Operation & Maintenance Manual must be performed **ONLY BY QUALIFIED BOBCAT SERVICE PERSONNEL**. Always use genuine Bobcat replacement parts. The Service Safety Training Course is available from your Bobcat dealer.

MSW01-0409



**Bobcat**®

**SERVICE SCHEDULE**

**Chart**

Maintenance work must be done at regular intervals. Failure to do so will result in excessive wear and early failures. The service schedule is a guide for correct maintenance of the Bobcat Loader.

 <b>WARNING</b>	<p>Instructions are necessary before operating or servicing machine. Read and understand the Operation &amp; Maintenance Manual, Operator's Handbook and signs (decals) on machine. Follow warnings and instructions in the manuals when making repairs, adjustments or servicing. Check for correct function after adjustments, repairs or service. Untrained operators and failure to follow instructions can cause injury or death.</p> <p style="text-align: right;">W-2003-0807</p>
--	--

SERVICE SCHEDULE		HOURS						
		8-10	50	100	150	■ 250	■ 500	■ 1000
ITEM	SERVICE REQUIRED							
Engine Oil	Check the oil level and add as needed. Do not overfill.							
Engine Air Filter and Air System	Check condition indicator. Service only when required. Check for leaks and damaged components.							
Engine Cooling System	Clean debris from oil cooler, radiator and grille. Check coolant level COLD and add premixed coolant as needed.							
Fuel Filter	Remove the trapped water.							
Lift Arms, Cylinders, Bob-tach Pivots Pins and Wedges	Lubricate with multipurpose lithium based grease.							
Tyres	Check for damaged tyres and correct air pressure. Inflate to MAXIMUM pressure shown on sidewall of tyre.							
Seat Bar, Control Interlocks, Seat Belt	Check the condition of seat belt. Check the seat bar and control interlocks for correct operation. Clean dirt and debris from moving parts.							
Front Horn	Check for proper function.							
Bobcat Interlock Control Systems (BICS™)	Check for correct function. Lift and Tilt functions MUST NOT operate with seat bar raised. See details in this Manual.							
Safety Signs and Safety Treads	Check for damaged signs (decals) and safety treads. Replace any signs or safety treads that are damaged or worn.							
Operator Cab	Check the fastening bolts, washers and nuts. Check the condition of the cab.							
Indicators and Lights	Check for correct operation of all indicators and lights.							
Heater Filter (If Equipped)	Clean or replace filter as needed.							
Hydraulic Fluid, Hoses and Tubelines	Check fluid level and add as needed. Check for damage and leaks. Repair or replace as needed.							
Final Drive Trans. (Chaincase)	Check oil level and add oil as needed.							
Parking Brake, Foot Pedals and Steering Levers	Check for correct operation. Repair or adjust as needed.							
Wheel Nuts	Check for loose wheel nuts and tighten to correct torque. (See TYRE MAINTENANCE in this manual.)	□						
Battery	Check cables, connections and electrolyte level. Add distilled water as needed.							
Spark Arrester Muffler	Empty Spark Chamber.							
Engine Oil and Filter	Replace oil and filter.		*					
Alternator Belt	Check tension and adjust as needed.							
Fuel Filter	Replace filter element.							
Steering Shaft	Grease fittings.							
Engine / Hydro. Drive Belt	Check for wear or damage. Adjust or replace as needed.							
Bobcat Interlock Control System (BICS™)	Check the function of the lift arm bypass control.		○					
Hydraulic Reservoir Breather Cap	Replace the reservoir breather cap.							
Hyd./Hydro. Filter	Replace the filter element.							
Final Drive Trans. (Chaincase)	Replace the fluid.							
Hydraulic Reservoir	Replace the fluid.							
Coolant	Replace the coolant							Every 2 years

- Check every 8-10 hours for the first 50 hours, then as scheduled.
- \* First oil and filter change must occur at 50 hours, then as scheduled.
- Inspect new belt after first 50 hours, then as scheduled.
- Replace the hydraulic / hydrostatic filter element after the first 50 hours; thereafter when the transmission warning light comes ON while operating or as scheduled.
- Or every 12 months.

NOTE: The Inspection Checkbook can be ordered for you by your local dealer. Part number 4420300.

**d** Torkonjestraat 23  
8510 Marke  
Belgium



056 / 222 111



rental@dumarent.be



www.dumarent.be

#### SERVICE SCHEDULE (CONT'D)

##### Inspection Checkbook

Regularly scheduled maintenance is essential to continuous operation and operating safety. The life expectancy of your machine depends on proper and meticulous care.

The Inspection Checkbook contains the following information:

- Doosan Benelux S.A. Warranty Conditions
- Protection Plus Extended Warranty Conditions
- General Parts Policy
- General Information
- First Inspection
- Scheduled Services
- Identification
- Authorised Identification
- Lubricants and Fluids Table
- Service Parts Chart

Your local dealer can order the Inspection Checkbook.  
Part number: 4420300.

#### BOBCAT INTERLOCK CONTROL SYSTEM (BICS™)

Perform the procedures on flat level ground and make sure the area is clear of bystanders.

#### Inspecting The BICS™ (Engine STOPPED - Key ON)

Figure 84

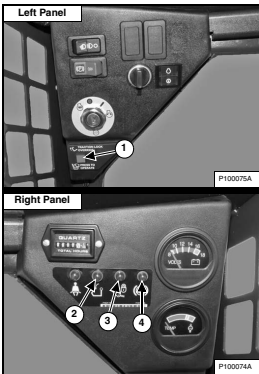

1. Sit in the operator's seat, fasten the seat belt, turn the key ON (Keyless Start Panel - enter the password / user code on the keypad), lower the seat bar and disengage the parking brake. Press the PRESS TO OPERATE LOADER button (Item 1). The three BICS™ lights (Items 2, 3 and 4) on the right instrument panel must be OFF (SEAT BAR, LIFT & TILT VALVE, and PARKING BRAKE) [Figure 84].
2. Raise the seat bar fully. The three BICS™ lights (Items 2, 3 and 4) [Figure 84] on the right instrument panel must be ON (SEAT BAR, LIFT & TILT VALVE, and PARKING BRAKE).

**NOTE:** Record what lights are blinking (if any) and the number of light flashes.

#### Inspecting The Seat Bar Sensor (Engine RUNNING)

3. Fasten the seat belt, lower the seat bar and make sure the parking brake is engaged.
4. Start the engine and operate at low idle. Press the PRESS TO OPERATE LOADER button. While raising the lift arms, raise the seat bar fully. The lift arms must stop. Repeat using the tilt function.

#### Inspecting The Traction Lock (Engine RUNNING)

5. Fasten seat belt, lower the seat bar, disengage the parking brake and press the PRESS TO OPERATE LOADER button. Raise the seat bar fully and move the steering levers slowly forward and backward. The traction drive system will be locked.
6. Fasten seat belt, lower the seat bar and press the PRESS TO OPERATE LOADER button. Engage the parking brake and move the steering levers slowly forward and backward. The traction drive system will be locked.

**NOTE:** The PARKING BRAKE light on the left instrument panel will remain ON until the engine is started, the PRESS TO OPERATE LOADER button is pressed and the parking brake is disengaged.

#### Inspecting The Lift Arm Bypass Control

7. Raise the lift arms 2 m (6 ft) off the ground. Stop the engine. Turn the lift arm bypass control knob clockwise 1/4 turn. Pull out and hold the knob until the lift arms slowly lower.

### ⚠ WARNING

**AVOID INJURY OR DEATH**  
 The Bobcat Interlock Control System (BICS) must deactivate the lift, tilt, traction drive and front auxiliary hydraulic functions. If it does not, contact your dealer for service. DO NOT modify the system.

W-2689-1007

**BOBCAT INTERLOCK CONTROL SYSTEM (BICS™) (CONT'D)**

**Inspecting Deactivation Of The Auxiliary Hydraulics System**

Perform the procedures on flat level ground and make sure the area is clear of bystanders.

**Figure 85**

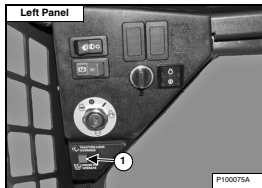

*Engine Starting*

8. Install an attachment with hydraulic connections. (See Installing And Removing The Attachment on Page 59.) Perform the pre-starting procedure. (See PRE-STARTING PROCEDURE on Page 49.) Fasten the seat belt, lower the seat bar and make sure the parking brake is engaged. Start the engine. Move the Auxiliary Hydraulic Control Lever to the left or the right. (See Front Auxiliary Hydraulics Operation on Page 44.). There will not be hydraulic oil flow to the attachment.

Press the PRESS TO OPERATE LOADER button (Item 1) [Figure 85] and then engage the auxiliary hydraulics. The auxiliary hydraulic oil will flow to the attachment.

*Engine Running*

9. Install an attachment with hydraulic connections. (See Installing And Removing The Attachment on Page 59.) Perform the pre-starting procedure. (See PRE-STARTING PROCEDURE on Page 49.) Fasten the seat belt, lower the seat bar and make sure the parking brake is engaged. Start the engine. Press the PRESS TO OPERATE LOADER button (Item 1) [Figure 85]. Move the Auxiliary Hydraulic Control Lever to the left or the right. The auxiliary hydraulic oil will flow to the attachment. (See Front Auxiliary Hydraulics Operation on Page 44.) Raise the seat bar. The auxiliary hydraulic oil flow to the attachment will STOP.

**⚠ WARNING**

**AVOID INJURY OR DEATH**

The Bobcat Interlock Control System (BICS) must deactivate the lift, tilt, traction drive and front auxiliary hydraulic functions. If it does not, contact your dealer for service. **DO NOT** modify the system.

W-2689-1007



## SEAT BAR RESTRAINT SYSTEM

### Description

The seat bar restraint system has a pivoting seat bar with armrests.

The operator controls the use of the seat bar. The seat bar in the down position helps to keep the operator in the seat.

The foot pedals have mechanical interlocks for the lift and tilt functions. The mechanical interlocks require the operator to lower the seat bar in order to operate the foot pedal controls.

When the seat bar is down, the PRESS TO OPERATE LOADER button is activated and the engine is running, the lift, tilt and traction drive functions can be operated.

When the seat bar is up, the lift and tilt control pedals are locked when returned to the NEUTRAL position.

### Inspecting

Sit in the seat and fasten the seat belt. Engage the parking brake. Pull the seat bar all the way down. Start the engine. Press the PRESS TO OPERATE LOADER button.

Operate the hydraulic controls to check that both the lift and tilt functions operate correctly. Raise the lift arms until the attachment is about 600 mm (2 ft) off the ground.

Raise the seat bar. Move the hydraulic controls. Pedals must be firmly locked in the NEUTRAL position. There must be no motion of the lift arms or tilt (attachment) when the controls are moved.

Lower the seat bar, press the PRESS TO OPERATE LOADER button, lower the lift arms. Operate the lift control. While the lift arms are going up, raise the seat bar. The lift arms must stop.

Lower the seat bar, press the PRESS TO OPERATE LOADER button, lower the lift arms and put the attachment flat on the ground. Stop the engine. Raise the seat bar. Operate the foot pedals to be sure they are firmly locked in the NEUTRAL position.



**The seat bar system must deactivate the lift and tilt control functions when the seat bar is up. See your Bobcat dealer for service if hydraulic controls do not deactivate.**

W2465-111

### Maintaining

See the service schedule for correct service interval. (See SERVICE SCHEDULE on Page 75.)

Figure 86

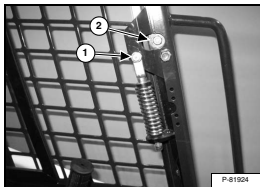
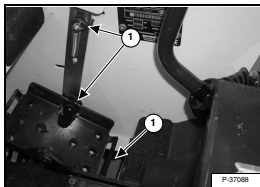

Figure 87



Use compressed air to clean any debris or dirt from the pivot parts (Item 1) [Figure 86] and [Figure 87]. Do not lubricate. Inspect all mounting hardware. The correct bolt torque is 34 - 38 N•m (25 - 28 ft-lb) for the seat bar pivot (Item 2) [Figure 86].

If the seat bar system does not function correctly, check for free movement of each linkage part. Check for excessive wear. Adjust pedal control linkage. Replace parts that are worn or damaged. Use only genuine Bobcat replacement parts.

## SEAT BELT

### Inspection And Maintenance



## WARNING

Failure to properly inspect and maintain the seat belt can cause lack of operator restraint resulting in serious injury or death.

W-2466-0703

Check the seat belt daily for correct function.

Inspect the seat belt system thoroughly yearly or more often if the machine is exposed to severe environmental conditions or applications.

The seat belt system should be repaired or replaced if it shows cuts, fraying, extreme or unusual wear, significant discolourations due to ultraviolet (UV) rays from the sun, dusty/dirty conditions, abrasion to the seat belt webbing, or damage to the buckle, latch plate, retractor (if equipped), or hardware.

The items below are referenced in **[Figure 88]**.

1. Check the seat belt webbing. If the system is equipped with a retractor, pull the webbing completely out and inspect the full length of the webbing. Look for cuts, wear, fraying, dirt and stiffness.
2. Check the buckle and latch for proper function. Make sure latch plate is not excessively worn, deformed or buckle is not damaged.
3. Check the retractor web storage device (if equipped) by extending the seat belt webbing to determine if it extends and retracts the webbing correctly.
4. Check webbing in areas exposed to ultraviolet (UV) rays from the sun or extreme dust or dirt. If the original colour of the webbing in these areas is extremely faded and / or the webbing is packed with dirt, the webbing strength may have weakened.

See your Bobcat dealer for approved seat belt system replacement parts for your machine.

Figure 88

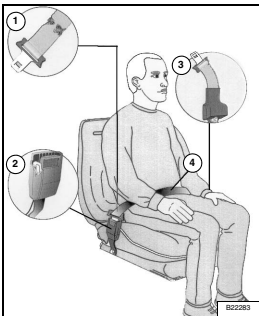

**LIFT ARM SUPPORT DEVICE**

**Installing**

Maintenance and service work can be done with the lift arms lowered. If the lift arms are raised, use the following procedures to engage and disengage an approved lift arm support device.



Never work on a machine with the lift arms up unless the lift arms are secured by an approved lift arm support device. Failure to use an approved lift arm support device can allow the lift arms or attachment to fall and cause injury or death.

Service lift arm support device if damaged or if parts are missing. Using a damaged lift arm support or with missing parts can cause lift arms to drop causing injury or death.

W-2572-0407

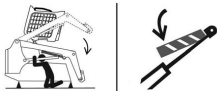

P-90328

**AVOID DEATH**

- Disconnecting or loosening any hydraulic tubeline, hose, fitting, component or a part failure can cause lift arms to drop.
- Keep out of this area when lift arms are raised unless supported by an approved lift arm support. Replace if damaged.

D-1009-0409

Remove the attachment from the loader. (See Installing And Removing The Attachment on Page 59.)



Before the cab or the lift arms are raised for service, jackstands must be put under the rear corners of the frame. Failure to use jackstands can allow the machine to tip backward causing injury or death.

W-2014-0895

Figure 89

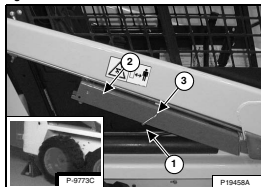

Put jackstands under the rear corners of the loader frame (Inset) [Figure 89].

Disconnect the spring (Item 1) from the lift arm support device retaining pin, Support the lift arm support device (Item 2) with your hand and remove the retaining pin (Item 3) [Figure 89].

Figure 90



Lower the lift arm support device to the top of the lift cylinder. Hook the free end of the spring (Item 1) [Figure 90] to the lift arms support device so there will be no interference with the support device engagement.

#### LIFT ARM SUPPORT DEVICE (CONT'D)

##### Installing (Cont'd)

With the operator in the seat, seat belt fastened and seat bar lowered, start the engine, press the PRESS TO OPERATE LOADER Button.

Figure 91

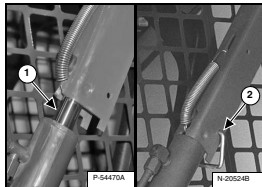

Raise the lift arms until the lift arm support device drops onto the lift cylinder rod (Item 1) [Figure 91].

Lower the lift arms slowly until the support device is held between the lift arm and the lift cylinder.

Stop the engine. Raise the seat bar and move both pedals until both pedals lock.

Install pin (Item 2) [Figure 91] into the rear of the lift arm support device below the cylinder rod.

##### Removing

Figure 92

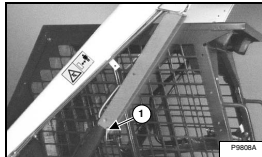

Remove the retaining pin (Item 1) [Figure 92] from the lift arm support device.

Figure 93

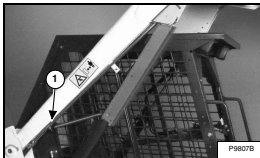

Connect the spring from the lift arm support device to the tubeline bracket (Item 1) [Figure 93] on the lift arms.

With the operator in the seat, seat belt fastened and seat bar lowered, start the engine, press the PRESS TO OPERATE LOADER button.

Raise the lift arms a small amount. The spring will lift the support device off the lift cylinder rod.

Lower the lift arms and stop the engine.

Raise the seat bar, disconnect the seat belt and move the pedals until both pedals lock.

Disconnect the spring from the bracket.

Figure 94

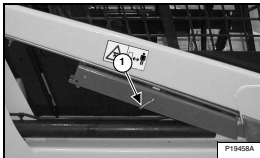

Raise the support device into storage position and insert the pin through the lift arm support device and bracket (Item 1) [Figure 94].

Connect the spring to the pin [Figure 94]

Remove the jackstands.



## BACK-UP ALARM SYSTEM

This machine may be equipped with a back-up alarm.

### Description

The back-up alarm will sound when the operator moves both steering levers into the reverse position. Slight movement of the steering levers into the reverse position is required with hydrostatic transmissions, before the back-up alarm will sound.

## Inspecting

### Figure 95



Inspect for damaged or missing back-up alarm decal (Item 1) [Figure 95]. Replace if required.

Sit in the seat and fasten the seat belt. Engage the parking brake. Pull the seat bar all the way down. Start the engine. Press the PRESS TO OPERATE LOADER button. Disengage the parking brake.

Move both steering levers into the reverse position. The back-up alarm must sound when all wheels are moving in reverse.

The back-up alarm is located on the inside of the rear door.

### Figure 96

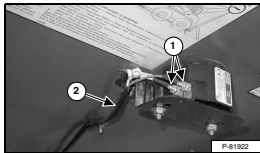

Inspect the back-up alarm electrical connections (Item 1) [Figure 96], wire harness (Item 2) [Figure 96] and back-up alarm switches (Item 1) [Figure 97] or [Figure 97] for tightness and damage. Repair or replace any damaged components.

If the back-up alarm switches require adjustment, (See Adjusting Switch Position on Page 84.)



056 / 222 111



rental@dumarent.be



www.dumarent.be

#### BACK-UP ALARM SYSTEM (CONT'D)

##### Adjusting Switch Position

Stop the engine and exit the loader. (See STOPPING THE ENGINE AND LEAVING THE LOADER on Page 57.)

Raise the operator cab. (See OPERATOR CAB on Page 85.)

##### Earlier Models

Place the steering levers in the neutral position.

Figure 97

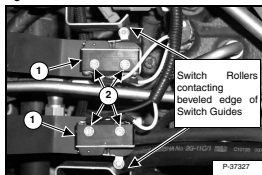

Loosen the screws (Item 2) securing the back-up alarm switches (Item 1) [Figure 97].

Position the back-up alarm switch rollers so that they just make contact with the beveled edge of the switch guides without compressing the switch springs. Torque the screws (Item 2) [Figure 97] securing the switches to the bracket to 1,6 - 2,1 N•m (14 - 19 in-lb).

##### Later Models

Figure 98

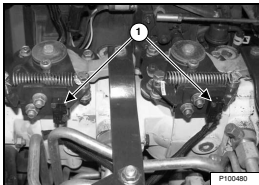

The back-up alarm switches (Item 1) [Figure 98] are located on the hydrostatic pump controls.

**NOTE:** The back-up alarm switches on later model loaders do not require adjustment. See your Bobcat dealer for service if your back-up alarm does not sound.

##### All Models

Lower the operator cab. (See Lowering on Page 86.)

Inspect back-up alarm system for proper function. (See Inspecting on Page 83.)

## OPERATOR CAB

### Description

The Bobcat Loader has an operator cab (ROPS and FOPS) as standard equipment to protect the operator from rollover and falling objects. The seat belt must be worn for rollover protection.

Check the ROPS / FOPS cab, mounting and hardware for damage. Never modify the ROPS / FOPS cab. Replace the cab and hardware if damaged. See your Bobcat dealer for parts.

ROPS / FOPS - Roll Over Protective Structure per ISO 3471, and Falling Object Protective Structure per ISO 3449, Level I.

Level I - Protection from falling bricks, small concrete blocks, and hand tools encountered in operations such as motorway maintenance, landscaping, and other construction sites.

### Raising

Always stop the engine before raising or lowering the cab.

Stop the loader on a level surface and lower the lift arms. If the lift arms must be up while raising the operator cab, install the lift arm support device. (See LIFT ARM SUPPORT DEVICE on Page 81.)

## WARNING

Before the cab or the lift arms are raised for service, jackstands must be put under the rear corners of the frame. Failure to use jackstands can allow the machine to tip backward causing injury or death.

W-2014-0895

## WARNING

Never modify operator cab by welding, grinding, drilling holes or adding attachments unless instructed to do so by Bobcat Company. Changes to the cab can cause loss of operator protection from rollover and falling objects, and result in injury or death.

W-2069-0200

## DANGER



P-90328

### AVOID DEATH

- Disconnecting or loosening any hydraulic tubeline, hose, fitting, component or a part failure can cause lift arms to drop.
- Keep out of this area when lift arms are raised unless supported by an approved lift arm support. Replace if damaged.

D-1009-0409



056 / 222 111



rental@dumarent.be



www.dumarent.be

## OPERATOR CAB (CONTD)

### Raising (Cont'd)

Figure 99

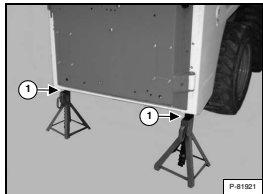

Install jackstands (Item 1) [Figure 99] under the rear corners of the loader frame.

Figure 100

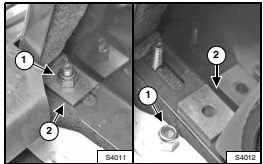

Remove the nut and plate (Items 1 and 2) [Figure 100] on the inside front corner of the cab (both sides).

Figure 101



Lift on the grab handle and bottom of the operator cab slowly until the cab is all the way up and the latching mechanism engages [Figure 101].

### Lowering

## ⚠ WARNING

### AVOID INJURY OR DEATH

The cab must be held to prevent falling while hand is in access hole.

W-2205-1207

Always stop the engine before raising or lowering the cab.

Figure 102

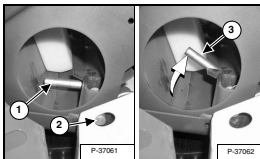

Hold the operator cab. Release the locking mechanism by pushing the lever (Item 1) in from the locked position (Item 2) and turning the lever until it stays in the unlocked position (Item 3) [Figure 102].



**OPERATOR CAB (CONTD)**

**Lowering (Cont'd)**

REMOVE YOUR HAND FROM THE HOLE BEFORE LOWERING THE OPERATOR CAB.

Stand on the ground and pull the cab down. Avoid slippery surfaces. Use both hands to lower the cab all the way down.

**NOTE:** The weight of the cab increases when equipped with options and accessories such as cab door, heater, etc. In these cases, the cab may need to be raised slightly from the latch to be able to release the latch.

**NOTE:** Always use the grab handles (once you can reach them) to lower the cab.

**Figure 103**

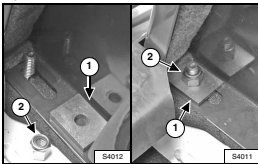

Install the plates and nuts (Items 1 and 2) [Figure 103] (both sides).

Tighten the nuts to 54 - 61 N•m (40 - 45 ft-lb) torque.

**If equipped with a heater, do the following:**

*Earlier Model Heater*

**NOTE:** The heater hose connectors will disconnect when the cab is raised. The heater hose connectors must be reconnected for the heater to work after the cab is lowered and secured.

Move the seat as far forward as needed to access the heater hose connectors that are located at the rear of the cab.

**Figure 104**

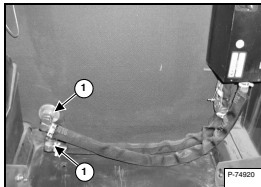

From behind the operator's seat, push the two heater quick connectors (Item 1) [Figure 104] into the heater couplers.

*Later Model Heater*

The heater hoses are routed through the rear wall of the cab behind the heater and will remain connected while raising and lowering the cab.

d Torkonjestraat 23  
8510 Marke  
Belgium

☎ 056 / 222 111  
✉ rental@dumarent.be  
🌐 www.dumarent.be

## REAR DOOR (TAILGATE)

### Opening And Closing

## ⚠ WARNING

### AVOID INJURY OR DEATH

Never service or adjust the machine when the engine is running unless instructed to do so in the manual.

W-2012-0497

Figure 105

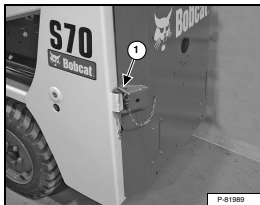

Remove the latch pin (Item 1) [Figure 105] and pull the rear door open.

Open the rear door for engine service.

## ⚠ WARNING

Keep the rear door closed when operating the machine. Failure to do so could seriously injure a bystander.

W-2020-1285

Close the rear door before operating the loader.

## AIR CLEANER SERVICE

### Replacing Filter Elements

Figure 106

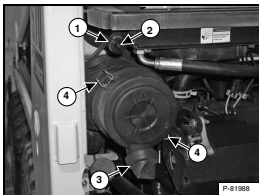

Replace the large (outer) filter element only when the red ring shows in the window of the condition indicator (Item 1) [Figure 106].

**NOTE:** Before replacing the filter element, push the button on the condition indicator (Item 2) [Figure 106]. Start the engine. If the red ring does not show, do not replace the filter element.

#### Outer Filter

Open the evacuator valve (Item 3) [Figure 106] to get rid of large particles of dust and dirt.

Remove the dust cover by lifting the latches (Item 4) [Figure 106].

Figure 107

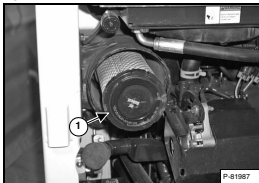

Pull the element straight out (Item 1) [Figure 107].

Install a new outer element.

Install the dust cover [Figure 106].

Check the air intake hose and the air cleaner housing for damage. Make sure all connections are tight.

#### Inner Filter

Replace the inner filter every third time the outer filter is replaced or when the red ring still shows in the indicator window after the outer filter has been replaced.

Figure 108

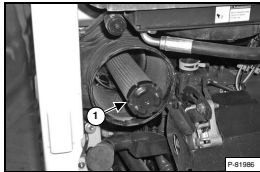

Remove the inner filter (Item 1) [Figure 108].

**NOTE:** Make sure all sealing surfaces are free of dirt and debris.

Install a new inner element.

Install the outer element.

Install the dust cover [Figure 106].

## FUEL SYSTEM

### Fuel Specifications

Use only clean, high quality diesel fuel, Grade No. 2 or Grade No. 1.

The following is one suggested blending guideline which should prevent fuel gelling during cold temperatures:

TEMPERATURE C° (F°)	NO. 2	NO. 1
-9° (+15°)	100%	0%
Down to -29° (-20°)	50%	50%
Below -29° (-20°)	0%	100%

At a minimum, low sulfur diesel fuel must be used in this machine. Low sulfur is defined as 500 mg/kg (500 ppm) sulfur maximum.

The following fuels may also be used in this machine:

- Ultra low sulfur diesel fuel. Ultra low sulfur is defined as 15 mg/kg (15 ppm) sulfur maximum.
- Biodiesel blend fuel - Must contain no more than five percent biodiesel mixed with low sulfur or ultra low sulfur petroleum based diesel. This is commonly marketed as B5 blended diesel fuel. B5 blended diesel fuel must meet ASTM D975 (US Standard) or EN590 (EU Standard) specifications.

### Biodiesel Blend Fuel

Biodiesel blend fuel has unique qualities that should be considered before using in this machine:

- Cold weather conditions can lead to plugged fuel system components and hard starting.
- Biodiesel blend fuel is an excellent medium for microbial growth and contamination which can cause corrosion and plugging of fuel system components.
- Use of biodiesel blend fuel may result in premature failure of fuel system components, such as plugged fuel filters and deteriorated fuel lines.
- Shorter maintenance intervals may be required, such as cleaning the fuel system and replacing fuel filters and fuel lines.
- Using biodiesel blended fuels containing more than five percent biodiesel can affect engine life and cause deterioration of hoses, tubelines, injectors, injector pump and seals.

Apply the following guidelines if biodiesel blend fuel is used:

- Ensure the fuel tank is as full as possible at all times to prevent moisture from collecting in the fuel tank.
- Ensure that the fuel tank cap is securely tightened.
- Biodiesel blend fuel can damage painted surfaces, remove all spilled fuel from painted surfaces immediately.
- Drain all water from the fuel filter daily before operating the machine.
- Do not exceed engine oil change interval. Extended oil change intervals can cause engine damage.
- Before vehicle storage; drain the fuel tank, refill with 100% petroleum diesel fuel, add fuel stabiliser and run the engine for at least 30 minutes.

**NOTE: Biodiesel blend fuel does not have long term stability and should not be stored for more than three months.**

## FUEL SYSTEM (CONT'D)

### Filling The Fuel Tank



**AVOID INJURY OR DEATH**  
 Stop and cool the engine before adding fuel. **NO SMOKING!** Failure to obey warnings can cause an explosion or fire.

W-2063-0807

Figure 109

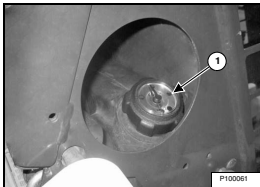

The fuel gauge (Item 1) [Figure 109] is located on the right side of the loader.

Figure 110

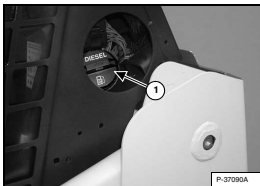

Remove the fill cap (Item 1) [Figure 110].

Figure 111

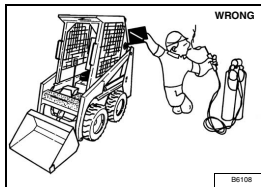

Use a clean, approved safety container to add fuel of the correct specification. Add fuel only in an area that has free movement of air and no open flames or sparks. **NO SMOKING!** [Figure 111].

Install and tighten the fuel fill cap (Item 1) [Figure 110].



**AVOID INJURY OR DEATH**  
 Always clean up spilled fuel or oil. Keep heat, flames, sparks or lighted tobacco away from fuel and oil. Failure to use care around combustibles can cause explosion or fire.

W-2103-0508

## FUEL SYSTEM (CONT'D)

### Fuel Filter

For the service interval for removing water from, or replacing the fuel filter (See SERVICE SCHEDULE on Page 75.)

#### Removing Water

Figure 112

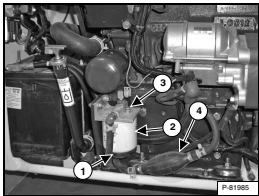

Loosen the drain (Item 1) [Figure 112] at the bottom of the filter element to remove water from the filter.

#### Replacing Element

Remove the filter element (Item 2) [Figure 112].

Clean the area around the filter housing. Put clean oil on the seal of the new filter element. Install the fuel filter, and hand tighten.

Remove air from the fuel system. (See Removing Air From The Fuel System on Page 92.)

#### Removing Air From The Fuel System

After replacing the filter element or when the fuel tank has run out of fuel, the air must be removed from the fuel system before starting the engine.

Open the vent (Item 3) [Figure 112] on the fuel filter housing.

## WARNING

### AVOID INJURY OR DEATH

Diesel fuel or hydraulic fluid under pressure can penetrate skin or eyes, causing serious injury or death. Fluid leaks under pressure may not be visible. Use a piece of cardboard or wood to find leaks. Do not use your bare hand. Wear safety goggles. If fluid enters skin or eyes, get immediate medical attention from a doctor familiar with this injury.

W-2072-EN-0909

Squeeze the hand pump (priming bulb) (Item 4) [Figure 112] until there are no air bubbles exiting the vent.

Close the vent (Item 3) [Figure 112] on the fuel filter housing.

With the operator in the seat, seat belt fastened, seat bar lowered and parking brake engaged, start the engine.

**NOTE: If the engine fails to start, remove air from the fuel injection pump as follows.**

Put jackstands under rear of the frame and raise operator cab. (See Raising on Page 85.)

Figure 113

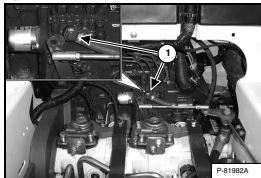

Open the valve (Item 1) [Figure 113] on the injector pump and squeeze the hand pump (Item 4) [Figure 112] several times until fuel comes from the valve.

Close the valve.

Lower the operator cab. (See Lowering on Page 86.)

Remove jackstands.

## ENGINE LUBRICATION SYSTEM

### Checking And Adding Engine Oil

Check the engine oil level every day before starting the engine for the work shift.

Figure 114

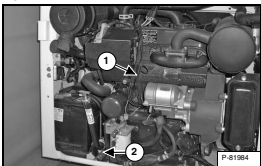

Park the machine on level ground. Open the rear door and remove the dipstick (Item 1) [Figure 114]. Keep the oil level between the marks on the dipstick. Do not overfill.

### Engine Oil Chart

Figure 115

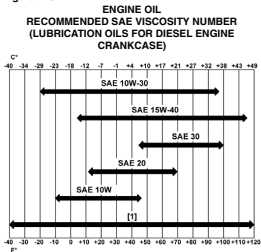

**TEMPERATURE RANGE ANTICIPATED BEFORE NEXT OIL CHANGE (DIESEL ENGINES MUST USE API CLASSIFICATION CI-4 OR BETTER)**

[1] Synthetic Oil - Use recommendation from Synthetic Oil Manufacturer.

Use good quality engine oil that meets API Service Classification of CI-4 or better [Figure 115].

### Removing And Replacing Oil And Filter

For the service interval for replacing the engine oil and filter (See SERVICE SCHEDULE on Page 75.)

Run the engine until it is at operating temperature. Stop the engine.

Open the rear door and remove the drain hose (Item 2) [Figure 114] from its storage position.

Figure 116

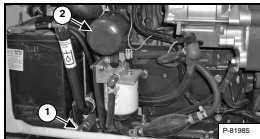

Remove the oil drain cap (Item 1) [Figure 116] and drain the oil into a container. Recycle or dispose of used oil in an environmentally safe manner.

Remove the oil filter (Item 2) [Figure 116] and clean the filter housing surface.

Use genuine Bobcat filter only. Put oil on the new filter gasket, install the filter and hand tighten.

Install and tighten the oil drain cap and return the drain hose to the stored position.

Remove the fill cap and put oil in the engine. For the correct quantity (See Capacities on Page 124.) Do not overfill.

Start the engine and let it run for several minutes. Stop the engine and check for leaks at the filter.

Add oil as needed if it is not at the top mark on the dipstick. Install the dipstick and close the rear door.

## WARNING

### AVOID INJURY OR DEATH

Always clean up spilled fuel or oil. Keep heat, flames, sparks or lighted tobacco away from fuel and oil. Failure to use care around combustibles can cause explosion or fire.

W-2103-0508

#### ENGINE COOLING SYSTEM

Check the cooling system every day to prevent overheating, loss of performance or engine damage.

#### Cleaning

Open the rear door.

Figure 117

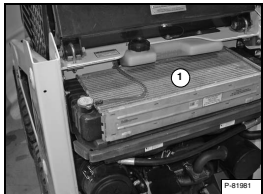

Use low air pressure or water pressure to clean the top of the radiator (Item 1) [Figure 117].

Check the cooling system for leaks.

Close the rear door.

#### Checking Level

Open the rear door.



## WARNING

#### AVOID INJURY OR DEATH

Wear safety glasses to prevent eye injury when any of the following conditions exist:

- When fluids are under pressure.
- Flying debris or loose material is present.
- Engine is running.
- Tools are being used.

W-2019-0907

Figure 118

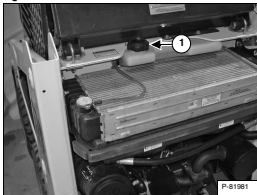

Remove the coolant fill cap (Item 1) [Figure 118]. Check the coolant level. The level markers are on the tank. Coolant must be at the bottom marker when the engine is cold and on the top marker when hot.

Use a refractometer to check the condition of propylene glycol in your cooling system.

Close the rear door before operating the loader.

## IMPORTANT

#### AVOID ENGINE DAMAGE

Always use the correct ratio of water to antifreeze.

Too much antifreeze reduces cooling system efficiency and may cause serious premature engine damage.

Too little antifreeze reduces the additives which protect the internal engine components; reduces the boiling point and freeze protection of the system.

Always add a premixed solution. Adding full strength concentrated coolant can cause serious premature engine damage.

I-2124-0497



## ENGINE COOLING SYSTEM (CONT'D)

### Removing And Replacing Coolant

Open the rear door.

Figure 119

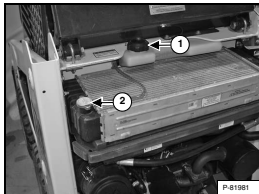

Remove the coolant fill cap (Item 1) [Figure 119].

Figure 120

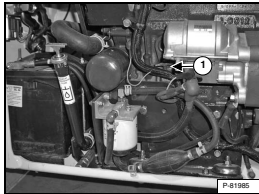

Connect a hose to the engine block drain valve (Item 1) [Figure 120] (located below the starter). Open the drain valve and drain the coolant into a container.

After all the coolant is removed, close the drain valve and remove the hose.

**NOTE:** Fluids such as engine oil, hydraulic fluid, coolant, etc. must be disposed of in an environmentally safe manner. Some regulations require that certain spills and leaks on the ground must be cleaned in a specific manner. See local bylaws for correct disposal.

Mix new coolant in a separate container. (See Capacities on Page 124.)

**NOTE:** The loader is factory filled with propylene glycol coolant (purple colour). DO NOT mix propylene glycol with ethylene glycol.

Remove the radiator cap (Item 2) [Figure 119] and fill the radiator with premixed coolant, 47% water and 53% propylene glycol. Reinstall the radiator cap.

The correct mixture of coolant to provide a -37°C (-34°F) freeze protection is 5 L propylene glycol mixed with 4,4 L of water **OR** 1 U.S. gal propylene glycol mixed with 3.5 qt of water.

Fill the recovery tank with premixed coolant until it is at the lower marker on the tank.

Use a refractometer to check the condition of propylene glycol in your cooling system and replace the coolant fill cap (Item 1) [Figure 119].

Run the engine until it is at operating temperature. After stopping the engine, let it cool down and check the coolant level again. Add coolant as needed.

Close the rear door.

## IMPORTANT

### AVOID ENGINE DAMAGE

Always use the correct ratio of water to antifreeze.

Too much antifreeze reduces cooling system efficiency and may cause serious premature engine damage.

Too little antifreeze reduces the additives which protect the internal engine components; reduces the boiling point and freeze protection of the system.

Always add a premixed solution. Adding full strength concentrated coolant can cause serious premature engine damage.

I-2124-0497

## ELECTRICAL SYSTEM

### Description

The loader has a 12 volt, negative earth alternator charging system. The electrical system is protected by fuses located in the engine compartment. The fuses will protect the electrical system when there is an electrical overload. The reason for the overload must be found before starting the engine again.

### Fuse And Relay Location / Identification

Figure 121

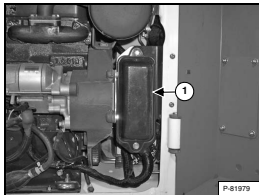

The electrical system is protected from overload by fuses and relays under the fuse panel cover (Item 1) [Figure 121]. A decal is inside the cover to show location and amperage ratings.

Figure 122



Remove the cover to check or replace the fuses [Figure 122].

Figure 123

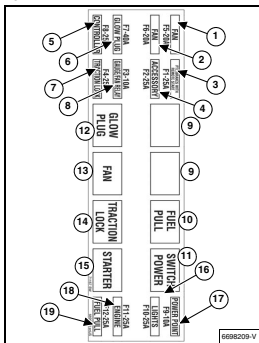

There is a decal [Figure 123] inside the fuse panel cover which shows location and size of fuses. Description and amperage ratings (or relays) are also shown below.

REF.	DESCRIPTION	AMPS	REF.	DESCRIPTION	AMPS
1	Fan	20	10	Fuel Solenoid	R
2	Fan	20	11	Switched Power	R
3	BICS/Brakes/Remote Start	25	12	Glow Plug	R
4	Accessory Back-up Alarm	25	13	Fan	R
5	Controller	25	14	Traction Lock	R
6	Glow Plug	40	15	Starter	R
7	Traction Lock	25	16	Lights	25
8	Gauge/Fan Relay	10	17	Power Point	10
9	Not Used	R	18	Engine/Horn	25
			19	Fuel Solenoid	25

R = Relay

**ELECTRICAL SYSTEM (CONT'D)**

**Battery Maintenance**

**Figure 124**

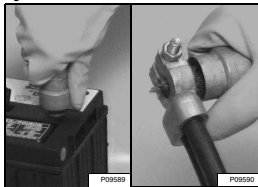

The battery cables must be clean and tight [Figure 124]. Check electrolyte level in the battery. Add distilled water as needed. Remove acid or corrosion from battery and cables with sodium bicarbonate (baking soda) and water solution.

Put Battery Saver (6988074) or grease on the battery terminals and cable ends to prevent corrosion.

**WARNING**

**AVOID INJURY OR DEATH**

Batteries contain acid which burns eyes and skin on contact. Wear goggles, protective clothing and rubber gloves to keep acid off body.

In case of acid contact, wash immediately with water. In case of eye contact get prompt medical attention and wash eye with clean, cool water for at least 15 minutes.

If electrolyte is taken internally drink large quantities of water or milk! DO NOT induce vomiting. Get prompt medical attention.

W-2065-0807

**Using A Booster Battery (Jump Starting)**

If it is necessary to use a booster battery to start the engine, BE CAREFUL! There must be one person in the operator's seat and one person to connect and disconnect the battery cables.

**Figure 125**

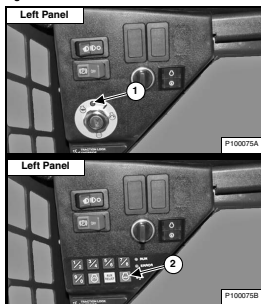

The key switch (Item 1) must be in the OFF position or the STOP button (Item 2) [Figure 125] must be pressed. The booster battery must be 12 volt.

**WARNING**

**BATTERY GAS CAN EXPLODE AND CAUSE SERIOUS INJURY OR DEATH**

Keep arcs, sparks, flames and lighted tobacco away from batteries. When *jumping* from booster battery make final connection (negative) at machine frame.

Do not jump start or charge a frozen or damaged battery. Warm battery to 16°C (60°F) before connecting to a charger. Unplug charger before connecting or disconnecting cables to battery. Never lean over battery while boosting, testing or charging.

W-2066-0910

#### ELECTRICAL SYSTEM (CONT'D)

Using A Booster Battery (Jump Starting) (Cont'd)

### WARNING

#### AVOID INJURY OR DEATH

Batteries contain acid which burns eyes and skin on contact. Wear goggles, protective clothing and rubber gloves to keep acid off body.

In case of acid contact, wash immediately with water. In case of eye contact get prompt medical attention and wash eye with clean, cool water for at least 15 minutes.

If electrolyte is taken internally drink large quantities of water or milk! DO NOT induce vomiting. Get prompt medical attention.

W-2065-0807

Remove the cable from the positive terminal (Item 2) [Figure 126].

### IMPORTANT

Damage to the alternator can occur if:

- Engine is operated with battery cables disconnected.
- Battery cables are connected when using a fast charger or when welding on the loader. (Remove both cables from the battery.)
- Extra battery cables (booster cables) are connected wrong.

I-2023-1285

Figure 126

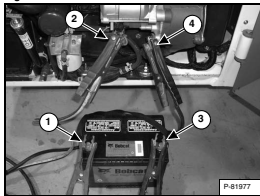

Connect the end of the first cable to the positive (+) terminal (Item 1) of the booster battery. Connect the other end of the same cable to the positive terminal (Item 2) [Figure 126] on the loader starter.

Connect the end of the second cable to the negative (-) terminal (Item 3) of the booster battery. Connect the other end of the same cable (Item 4) [Figure 126] to the engine.

**NOTE: Keep cables away from moving parts.**

Start the engine. (See STARTING THE ENGINE on Page 52.)

After the engine has started, remove the negative (-) cable (Item 4) [Figure 126] first.

## ELECTRICAL SYSTEM (CONT'D)

### Removing And Installing Battery

#### **WARNING**

##### AVOID INJURY OR DEATH

Batteries contain acid which burns eyes and skin on contact. Wear goggles, protective clothing and rubber gloves to keep acid off body.

In case of acid contact, wash immediately with water. In case of eye contact get prompt medical attention and wash eye with clean, cool water for at least 15 minutes.

If electrolyte is taken internally drink large quantities of water or milk! DO NOT induce vomiting. Get prompt medical attention.

W-2065-0807

Open the rear door.

Figure 127

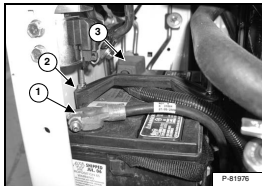

Disconnect the negative (-) battery cable (Item 1) [Figure 127].

Remove the battery hold down clamp (Item 2) [Figure 127].

Disconnect the positive (+) cable (Item 3) [Figure 127] from the battery.

Remove the battery from the loader.

**NOTE:** When removing or installing the battery in the loader, do not touch any metal parts with the battery terminals.

Figure 128

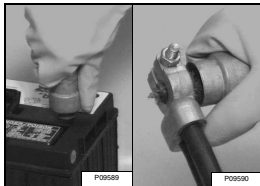

Always clean the battery terminals and cable ends when installing a new or used battery [Figure 128].

**NOTE:** Always connect the negative (-) cable last and remove it first to prevent sparks.

Connect the positive (+) battery cable.

Install and tighten the battery hold down clamp.

Connect the negative (-) battery cable.

Close the rear door before operating the loader.

## HYDRAULIC / HYDROSTATIC SYSTEM

### Checking And Adding Fluid

Check the hydraulic / hydrostatic fluid level every day before starting the work shift.

Park the loader on a level surface.

Lower the lift arms and tilt the Bob-Tach fully back.

Stop the engine and exit the loader. (See STOPPING THE ENGINE AND LEAVING THE LOADER on Page 57.)

Figure 129

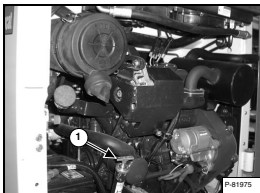

Remove the dipstick (Item 1) [Figure 129] and allow the oil level to stabilise for 10 - 5 seconds. Install the dipstick and remove to check the fluid level.

**NOTE:** Hydraulic oil level in the dipstick tube must be allowed to stabilise before it is checked or the dipstick may incorrectly indicate a low fluid condition.

If fluid is needed, add fluid through the dipstick / fill tube.

## Hydraulic / Hydrostatic Fluid Chart

Figure 130

### HYDRAULIC / HYDROSTATIC FLUID RECOMMENDED ISO VISCOSITY GRADE (VG) AND VISCOSITY INDEX (VI)

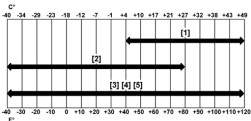

### TEMPERATURE RANGE ANTICIPATED DURING MACHINE USE

- [1] VG 100; Minimum VI 130
- [2] VG 46; Minimum VI 150
- [3] BOBCAT All-Season Fluid
- [4] BOBCAT Synthetic Fluid
- [5] BOBCAT Biodegradable Hydraulic / Hydrostatic Fluid (Unlike biodegradable fluids that are vegetable based, Bobcat biodegradable fluid is formulated to prevent oxidation and thermal breakdown at operating temperatures.)

Use only recommended fluid in the hydraulic system [Figure 130].



**HYDRAULIC / HYDROSTATIC SYSTEM (CONTD)**

**Removing And Replacing Hydraulic Fluid**

For the correct service interval (See **SERVICE SCHEDULE** on Page 75.)

Replace the fluid if it becomes contaminated or after major repair.

Always replace the hydraulic / hydrostatic filter whenever the hydraulic fluid is replaced. (See **Removing And Replacing Hydraulic / Hydrostatic Filter** on Page 102.)

**Figure 131**

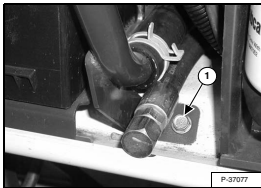

Remove the bolt (Item 1) [Figure 131] from the dipstick / fill tube mounting bracket.

**Figure 132**



Remove the dipstick from the hydraulic fill tube and rotate the tube down into a container [Figure 132] to drain the reservoir.

**NOTE:** Fluids such as engine oil, hydraulic fluid, coolant, etc. must be disposed of in an environmentally safe manner. Some regulations require that certain spills and leaks on the ground must be cleaned in a specific manner. See local bylaws for correct disposal.

After the hydraulic fluid is completely drained, rotate the hydraulic fill tube back to the original position and reinstall the bolt (Item 1) [Figure 131] to the fill tube mounting bracket.

Fill the hydraulic system with the correct amount and type of hydraulic fluid. (See **Hydraulic / Hydrostatic Fluid Chart** on Page 100.) and (See **Capacities** on Page 124.)

#### HYDRAULIC / HYDROSTATIC SYSTEM (CONT'D)

##### Removing And Replacing Hydraulic / Hydrostatic Filter

For the correct service interval (See SERVICE SCHEDULE on Page 75.)

Stop the engine and exit the loader. (See STOPPING THE ENGINE AND LEAVING THE LOADER on Page 57.)

Raise the operator cab. (See Raising on Page 85.)

Figure 133

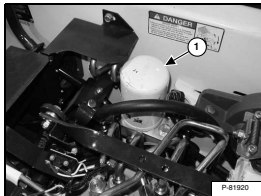

Remove the filter (Item 1) [Figure 133].

Clean the surface of the filter housing where the filter seal contacts the housing.

Put clean oil on the seal of the new filter element. Install and hand tighten the filter element.

#### **WARNING**

##### AVOID INJURY OR DEATH

Always clean up spilled fuel or oil. Keep heat, flames, sparks or lighted tobacco away from fuel and oil. Failure to use care around combustibles can cause explosion or fire.

W-2103-0508

Lower the operator cab. (See Lowering on Page 86.)

Start the engine and operate the loader hydraulic controls.

Stop the engine and exit the loader. (See STOPPING THE ENGINE AND LEAVING THE LOADER on Page 57.)

Check for leaks at the filter.

#### **WARNING**

##### AVOID INJURY OR DEATH

Diesel fuel or hydraulic fluid under pressure can penetrate skin or eyes, causing serious injury or death. Fluid leaks under pressure may not be visible. Use a piece of cardboard or wood to find leaks. Do not use your bare hand. Wear safety goggles. If fluid enters skin or eyes, get immediate medical attention from a doctor familiar with this injury.

W-2072-EN-0909

Check fluid level and add as needed. (See Checking And Adding Fluid on Page 100.)

##### Breather Cap

Replace the breather cap at the correct service interval. (See SERVICE SCHEDULE on Page 75.)

Raise the cab. (See Raising on Page 85.)

Figure 134

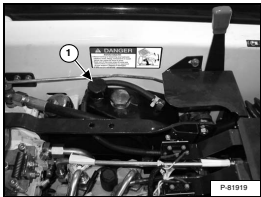

Thoroughly clean the area around the breather cap.

Remove the breather cap (Item 1) [Figure 134] and discard.

Install new breather cap.

Lower the cab. (See Lowering on Page 86.)



**SPARK ARRESTER MUFFLER**

**Cleaning Procedure**

See the SERVICE SCHEDULE for service interval for cleaning the spark arrester muffler. (See SERVICE SCHEDULE on Page 75.)

Do not operate the loader with a defective exhaust system.

**IMPORTANT**

This machine is factory equipped with a spark arrester exhaust system.

The spark arrester muffler, if equipped, must be cleaned to keep it in working condition. The spark arrester muffler must be serviced by dumping the spark chamber every 100 hours of operation.

On some models, the turbocharger functions as the spark arrester and must operate correctly for proper spark arrester function.

If this machine is operated on flammable forest, brush, or grass covered land, a spark arrester attached to the exhaust system may be required and must be maintained in working order. Refer to local laws and regulations for spark arrester requirements.

I-2284-EN-0909

Stop the engine and exit the loader. (See STOPPING THE ENGINE AND LEAVING THE LOADER on Page 57.)

Open the rear door.

Figure 135

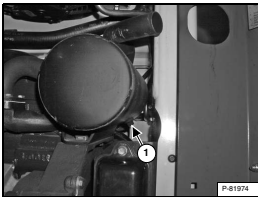

Remove the plug (Item 1) [Figure 135] from the bottom of the muffler.

**! WARNING**

When the engine is running during service, the driving and steering controls must be in neutral and the parking brake engaged. Failure to do so can cause injury or death.

W-2006-1209

Start the engine and run for about 10 seconds while a second person, wearing safety goggles, holds a piece of wood over the outlet of the muffler. This will force contaminants out through the cleanout hole.

Stop the engine and exit the loader. (See STOPPING THE ENGINE AND LEAVING THE LOADER on Page 57.)

Install and tighten the plug.

Close the rear door.

**! WARNING**

**AVOID INJURY OR DEATH**

When an engine is running in an enclosed area, fresh air must be added to avoid concentration of exhaust fumes. If the engine is stationary, vent the exhaust outside. Exhaust fumes contain odorless, invisible gases which can kill without warning.

W-2011-0807

**! WARNING**

Stop engine and allow the muffler to cool before cleaning the spark chamber. Wear safety goggles. Failure to obey can cause serious injury.

W-2011-1285

**! WARNING**

Never use machine in atmosphere with explosive dust or gases or where exhaust can contact flammable material. Failure to obey warnings can cause injury or death.

W-2068-1285

## TYRE MAINTENANCE

### Wheel Nuts

Figure 136



See the SERVICE SCHEDULE for the service interval to check the wheel nuts [Figure 136]. (See SERVICE SCHEDULE on Page 75.)

When installing wheel nuts, tighten to 217 N•m (160 ft-lb) torque.

When checking wheel nut torque, set the torque wrench to 190 N•m (140 ft-lb) to prevent over-tightening.

### Rotating

Check the tyres regularly for wear, damage and pressure. Inflate tyres to the maximum pressure shown on the sidewall of the tyre.

Figure 137

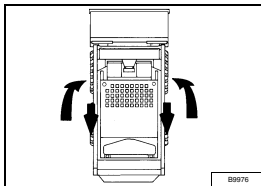

Rear tyres usually wear faster than front tyres. To keep tyre wear even, move the front tyres to the rear and rear tyres to the front [Figure 137].

It is important to keep all tyres the same size. If different sizes are used, each tyre will be turning at a different rate and cause excessive wear. The tread bars of all the tyres must face the same direction.

Recommended tyre pressure must be maintained to avoid excessive tyre wear and loss of stability and handling capability. Check for the correct pressure before operating the loader.

### Mounting

Tyres are to be repaired only by an authorised person using the proper procedures and safe equipment.

Tyres and rims must always be checked for correct size before mounting. Check rim and tyre bead for damage.

The rim flange must be cleaned and free of rust.

The tyre bead and rim flange must be lubricated with a rubber lubricant before mounting the tyre.

Avoid excessive pressure which can rupture the tyre and cause serious injury or death.

During inflation of the tyre, check the tyre pressure frequently to avoid over inflation.

## WARNING

**AVOID INJURY OR DEATH**  
 Do not inflate tyres above specified pressure. Failure to use correct tyre mounting procedure can cause an explosion which can result in injury or death.

I-2078-EN-0909

## IMPORTANT

Inflate tyres to the **MAXIMUM** pressure shown on the sidewall of the tyre. **DO NOT** mix brands of tyres used on the same machine.

I-2057-EN-1010

#### FINAL DRIVE TRANSMISSION (CHAINCASE)

##### Checking And Adding Oil

The chaincase contains the final drive sprockets and chains. Use the same type of oil as the hydraulic / hydrostatic system.

Park the loader on a level surface.

Stop the engine and exit the loader. (See STOPPING THE ENGINE AND LEAVING THE LOADER on Page 57.)

Install jackstands under the rear corners of the loader frame.

Enter the loader and raise the loader lift arms. Install the Lift Arm Support Device. (See LIFT ARM SUPPORT DEVICE on Page 81.)

Stop the engine and exit the loader. (See STOPPING THE ENGINE AND LEAVING THE LOADER on Page 57.)

Figure 138

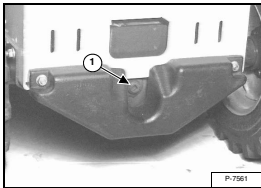

Remove the check plug (Item 1) [Figure 138] from the front of the chaincase housing.

If oil can be reached with the tip of your finger through the hole, the oil level is correct.

If the level is low, add lubricant through the check plug hole until the oil flows from the hole.

Install and tighten the plug.

Lower the lift arms. (See LIFT ARM SUPPORT DEVICE on Page 81.)

Remove jackstands.

##### Removing And Replacing Oil

Park the loader on a level surface.

Stop the engine and exit the loader. (See STOPPING THE ENGINE AND LEAVING THE LOADER on Page 57.)

Install jackstands under the rear corners of the loader frame.

Enter the loader and raise the loader lift arms. Install the Lift Arm Support Device. (See LIFT ARM SUPPORT DEVICE on Page 81.)

Stop the engine and exit the loader. (See STOPPING THE ENGINE AND LEAVING THE LOADER on Page 57.)

Remove the check plug (Item 1) [Figure 138] from the front of the chaincase housing.

Figure 139

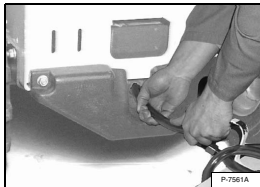

Use a pump to suction the oil from the chaincase [Figure 139].

Recycle or dispose of the used oil in an environmentally safe manner.

Add new oil until the oil flows from the hole.

Install and tighten the plug.

Lower the lift arms. (See LIFT ARM SUPPORT DEVICE on Page 81.)

Remove jackstands.

## ALTERNATOR BELT

### Belt Adjustment

Stop the engine and exit the loader. (See STOPPING THE ENGINE AND LEAVING THE LOADER on Page 57.)

Open the rear door. (See REAR DOOR (TAILGATE) on Page 88.)

Figure 140

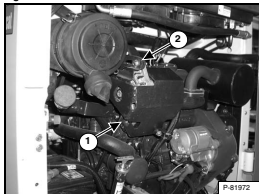

Loosen the alternator mounting bolt (Item 1) [Figure 140].

Loosen the adjustment bolt (Item 2) [Figure 140].

The tension is correct with 6 mm (1/4 in) belt movement at mid span when 67 N (15 lb) force is applied to the belt.

Tighten the adjustment bolt and mounting bolt.

Close the rear door.

### Belt Replacement

Stop the engine and exit the loader. (See STOPPING THE ENGINE AND LEAVING THE LOADER on Page 57.)

Open the rear door. (See REAR DOOR (TAILGATE) on Page 88.)

Loosen the alternator mounting and adjustment bolts (Items 1 and 2) [Figure 140] and loosen the belt all the way.

Remove the belt and install a new belt.

The tension is correct with 6 mm (1/4 in) belt movement at mid span when 67 N (15 lb) force is applied to the belt.

Tighten the adjustment bolt and mounting bolt.

Close the rear door.

## DRIVE BELT

### Belt Adjustment

The drive belt does not need adjustment. The belt has a spring loaded idler which is constantly adjusted.

### Belt Replacement

Stop the engine and exit the loader. (See STOPPING THE ENGINE AND LEAVING THE LOADER on Page 57.)

Open the rear door and disconnect the negative (-) cable from the battery.

Figure 141

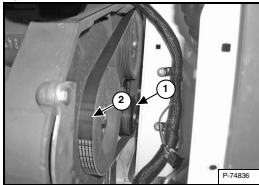

Use a socket wrench (without socket) to move the spring loaded belt tensioner (Item 1) [Figure 141] upward.

While holding the spring loaded belt tensioner up, you can remove the drive belt (Item 2) [Figure 141].

Carefully lower the spring loaded belt tensioner to its stop.

Install a new drive belt by reversing the above procedure.

## LUBRICATING THE LOADER

### Lubrication Locations

Lubricate the loader as specified for the best performance of the loader. (See SERVICE SCHEDULE on Page 75.)

Record the operating hours each time you lubricate the Bobcat Loader.

Always use a good quality lithium based multipurpose grease when you lubricate the loader. Apply the lubricant until extra grease shows.

Lubricate the following locations on the loader:

**Figure 142**

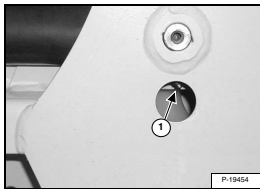

1. Base End Lift Cylinder (Both Sides) [Figure 142].

**Figure 143**

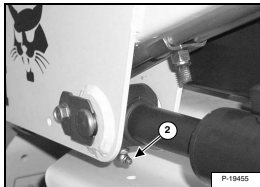

2. Rod End Lift Cylinder (Both Sides) [Figure 143].

**Figure 144**

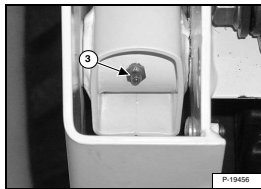

3. Lift Arm Pivot Pin (Both Sides) [Figure 144].

**Figure 145**

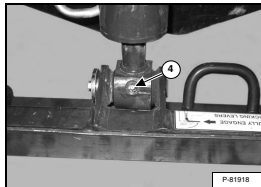

4. Rod End Tilt Cylinder [Figure 145].

**LUBRICATING THE LOADER (CONT'D)**

**Lubrication Locations (Cont'd)**

**Figure 146**

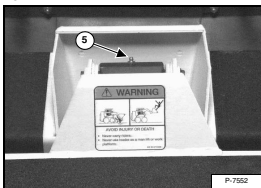

5. Base End Tilt Cylinder [Figure 146].

**Figure 147**

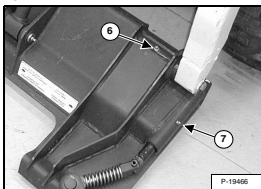

6. Bob-Tach Pivot Pin (Both Sides) [Figure 147].  
 7. Bob-Tach Wedge (Both Sides) [Figure 147].

**Figure 148**

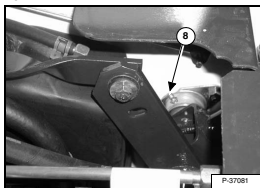

8. 250 Hours: Steering shaft pivot bearings (Both Sides) [Figure 148].

## PIVOT PINS

### Inspection And Maintenance

Figure 149

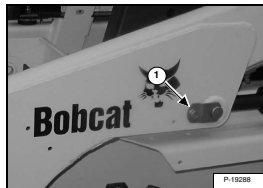
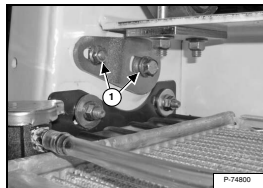

Figure 150



All lift arm and cylinder pivots have a large pin held in position with a retainer bolt and lock nut (Item 1) [Figure 149] and [Figure 150].

Tighten to 24 - 27 N•m (18 - 20 ft-lb) torque.

Do not over tighten.

Figure 151

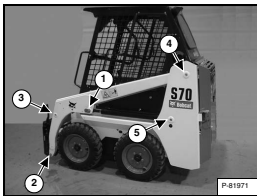
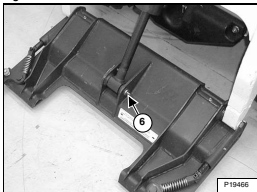

Figure 152



Check the following pivot pins (Items 1 - 6) [Figure 151] and [Figure 152].

Repeat for (Items 1 - 5) [Figure 151] on the opposite side of the loader.



**BOB-TACH**

**Inspection And Maintenance**

**Figure 153**

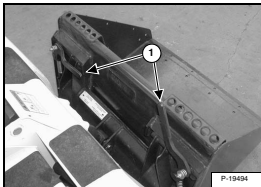

Move the Bob-Tach levers down to engage the wedges [Figure 153].

The levers and wedges must move freely.



**AVOID INJURY OR DEATH**

The Bob-Tach wedges must extend through the holes in the attachment mounting frame. Levers must be fully down and locked. Failure to secure wedges can allow attachment to come off.

W-2715-0208

**Figure 154**

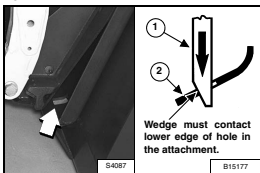

The wedges (Item 1) must extend through the holes in the attachment mounting frame (Item 2) [Figure 154].

The spring loaded wedge (Item 1) [Figure 154] must contact the lower edge of the hole in the attachment (Item 2).

If the wedge does not contact the lower edge of the hole [Figure 154], the attachment will be loose and can come off the Bob-Tach.

**Figure 155**

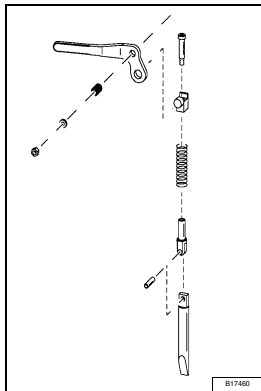

Inspect the mounting frame on the attachment and Bob-Tach, linkages and wedges for excessive wear or damage [Figure 155]. Replace any parts that are damaged, bent or missing. Keep all fasteners tight.

Look for cracked welds. Contact your Bobcat dealer for repair or replacement parts.

Lubricate the wedges. (See SERVICE SCHEDULE on Page 75.) and (See LUBRICATING THE LOADER on Page 108.)

#### LOADER STORAGE AND RETURN TO SERVICE

##### Storage

Sometimes it may be necessary to store your Bobcat Loader for an extend period of time. Below is a list of items to perform before storage.



- Thoroughly clean the loader including the engine compartment.
- Lubricate the loader.
- Replace worn or damaged parts.
- Park the loader in a dry protected shelter.
- Lower the lift arms all the way and put the bucket flat on the ground.
- Put blocks under the frame to remove weight from the tyres.
- Put grease on any exposed cylinder rods.
- Put fuel stabiliser in the fuel tank and run the engine a few minutes to circulate the stabiliser to the pump and fuel injectors.
- Drain and flush the cooling system. Refill with premixed coolant.
- Replace all fluids and filters (engine, hyd. / hydro.).
- Replace air cleaner, heater and air conditioning filters.
- Put all controls in neutral position.
- Remove the battery. Be sure the electrolyte level is correct then charge the battery. Store it in a cool dry place above freezing temperatures and charge it periodically during storage.
- Cover the exhaust pipe opening.
- Tag the machine to indicate that it is in storage condition.

##### Return To Service

After the Bobcat Loader has been in storage, it is necessary to follow a list of items to return the loader to service.

- Check the engine and hydraulic oil levels; check coolant level.
- Install a fully charged battery.
- Remove grease from exposed cylinder rods.
- Check all belt tensions.
- Be sure all shields and guards are in place.
- Lubricate the loader.
- Check tyre inflation and remove blocks from under frame.
- Remove cover from exhaust pipe opening.
- Start the engine and let run for a few minutes while observing the instrument panels and systems for correct operation.
- Operate machine, check for correct function.
- Stop the engine and check for leaks. Repair as needed.

**d** Torkonjestraat 23  
8510 Marke  
Belgium

 056 / 222 111  
 rental@dumarent.be  
 www.dumarent.be

**SYSTEM SETUP & ANALYSIS**

TRUBLESHOOTING .....	115
Troubleshooting The Engine .....	115
Troubleshooting The Hydraulic System .....	116
Troubleshooting The Hydrostatic System .....	116
BOBCAT INTERLOCK CONTROL SYSTEM (BICS™) .....	117
Troubleshooting .....	117
Viewing Diagnostic Service Codes .....	117



**\* Always follow manufacturer instructions \***

**d**

Torkonjestraat 23  
8510 Marke  
Belgium



056 / 222 111



rental@dumarent.be



www.dumarent.be



**Bobcat®**

**TROUBLESHOOTING**

The following information identifies loader problems which can occur most often. Service procedures for correcting loader problems can be found in this manual on the pages indicated. Some procedures are marked DS (Dealer Service) and must be performed only by qualified Bobcat service personnel.



**AVOID INJURY OR DEATH**

**When operating the machine:**

- **Keep the seat belt fastened snugly.**
- **The seat bar must be lowered.**
- **Keep your feet on the pedal controls or footrests and hands on the controls.**

W-2261-0909

**Troubleshooting The Engine**

PROBLEM	CAUSE	CORRECTION
Engine will not turn over with starter.	Battery has low charge.	Charge battery and find cause for loss of charge.
	Cables loose or dirty.	Clean and tighten battery cables.
	Damaged starter, solenoid or wiring	Check the starting circuit.
Engine turns with starter, but is difficult to start.	Wrong starting procedure.	Use correct starting procedure.
	No fuel in tank.	Add fuel.
	Dirt or water in fuel system.	Perform maintenance as needed.
	Damaged fuel pump.	Make repairs as needed.
	Fuel filter is dirty.	Install new filter.
	Hole in fuel line.	Make repairs as needed.
	Wrong oil in engine.	See Oil Specification
	Engine has lost compression.	Recondition the engine.
	Engine has overheated.	Check cooling system.
Poor fuel quality.	Use fresh, good quality fuel.	
Engine has little power or runs rough.	Dirt, water or air in fuel system.	Clean and repair as needed.
	Engine has overheated.	Check cooling system
	Governor adjustment is wrong.	Check and make adjustment if needed.
	Dirty air cleaner filter.	Check air cleaner, replace filter as needed.
	Engine has lost compression	Recondition the engine.
Engine overheats.	Cooling system is dirty. Air flow restricted.	Clean cooling system
	Engine shrouding damaged or missing.	Repair or replace.
	Engine is overloaded.	Run at full rpm

## TROUBLESHOOTING (CONT'D)

### Troubleshooting The Hydraulic System

PROBLEM	CAUSE	CORRECTION
No hydraulic action.	No hydraulic fluid.	Check fluid level and add as needed.
	Pedals are disconnected.	Check linkage. Repair as needed.
	Relief valve is damaged.	Replace the relief valve.
	Hydraulic pump is damaged.	Check pump and replace as needed.
	Hydraulic fluid is too thick. (cold temperature)	Let engine run to warm the hydraulic fluid.
Hydraulic action is rough.	Hydraulic fluid level is low.	Check fluid level and add as needed.
Hydraulic action is slow.	Pedal is hitting floor or debris under pedal.	Check adjustment. Remove dirt.
	Cylinders leak internally.	Check condition of cylinders and repair as needed.
	Hydraulic pump is damaged.	Check pump and replace as needed.
	Control valve is damaged	Check valve and repair as needed.
	Hydraulic fluid is too thick. (cold temperature)	Let engine run to warm the hydraulic fluid.
Hydraulic cylinders leak fluid.	Damage to cylinder rods or seals.	Repair cylinders.
No hydraulic flow to the front auxiliary hydraulic couplers.	Auxiliary hydraulic interlock valve closed.	Check auxiliary hydraulic interlock valve and solenoid for proper function. Repair or replace as needed.

### Troubleshooting The Hydrostatic System

PROBLEM	CAUSE	CORRECTION
No drive on both sides.	Hydraulic fluid is low.	Check fluid level. Add as needed.
	10 Micon filter is damaged.	Replace filter.
	Damaged gear pump.	Check condition of gear pump and replace if bad.
No drive on one side.	Hydrostatic system is damaged.	Check hydrostatic system.
	Control linkage is disconnected.	Repair linkage.
Machine pulls to one side.	Wrong tyre pressure.	Check all tyres
	Steering linkage interference.	Check steering linkage
	Damaged hydrostatic pump / motor.	Check system.
Machine moves when levers are in neutral.	Steering linkage out of adjustment.	Adjust steering linkage.
System is overheating.	Hydraulic fluid level is low.	Check fluid level.
	Plugged filter.	Install new filter element.
	Low charge pressure.	Check by-pass valve.
	Bobcat is overloaded.	Use correct size attachment and run engine at full rpm.
	Hydrostatic transmission damaged.	Check hydrostatic system.

### BOBCAT INTERLOCK CONTROL SYSTEM (BICS™)

#### Troubleshooting

The following list shows the probable causes when the BICS™ lights are off or flashing and the associated service codes. (See TROUBLESHOOTING on Page 115.)

Indicator Light	Light ON	Light OFF	Effect on Operation of Loader when Light is ON
①	Seat Bar <u>is</u> up.	Seat Bar is down.	Lift and tilt functions will not operate.
②	Control valve <u>cannot</u> be used.	Control valve can be used.	Lift and tilt functions will not operate.
③	Loader cannot be moved forward and backward.	Loader <u>can</u> be moved forward and backward.	Loader cannot be moved forward and backward.

#### Viewing Diagnostic Service Codes

The Seat Bar Light (Item 1), Valve Light (Item 2) and Parking Brake Light (Item 3) will flash to indicate SERVICE CODES. These lights may flash while the engine is running or with the engine OFF and the key ON.

**NOTE: Multiple SERVICE CODES and / or abnormal symptoms can be caused by a corroded or loose earth. Check earths and both battery connections.**

The list below contains SERVICE CODES. These codes help analyze monitored functions of your Bobcat loader. Some service procedures must be performed ONLY BY QUALIFIED BOBCAT SERVICE PERSONNEL.

Indicator Light	LED	Function	Failure
1	Seat Bar - 2 Flashes	Seat Sensor	Out of Range Low
		8 Volt Sensor Supply	Out of Range Low
1	Seat Bar - 3 Flashes	Seat Sensor	Out of Range High
		8 Volt Sensor Supply	Out of Range High
<hr/>			
2	Valve - 2 Flashes	Hydraulic Lock Valve Solenoid	Short to Battery
2	Valve - 3 Flashes	Hydraulic Lock Valve Solenoid	Short to Earth
2	Valve - 4 Flashes	Hydraulic Lock Valve Solenoid	Open Circuit
<hr/>			
3	Parking Brake - 1 Flash	Traction Lock Hold Solenoid	Open Circuit
3	Parking Brake - 2 Flashes	Traction Lock Hold Solenoid	Short to Battery
3	Parking Brake - 3 Flashes	Traction Lock Hold Solenoid	Short to Earth
3	Parking Brake - 4 Flashes	Traction Lock Pull Output	Open Circuit
3	Parking Brake - 5 Flashes	Traction Lock Pull Output	Error On
		Traction Pull Relay	Error On
3	Parking Brake - 6 Flashes	Traction Lock Pull Output	Error Off
		Traction Pull Relay	Error Off



**\* Always follow manufacturer instructions \***

**d**

Torkonjstraat 23  
8510 Marke  
Belgium



056 / 222 111



rental@dumarent.be



www.dumarent.be



**Bobcat®**



**d** Torkonjestraat 23  
8510 Marke  
Belgium



056 / 222 111



rental@dumarent.be



www.dumarent.be

## SPECIFICATIONS

(S70) LOADER SPECIFICATIONS .....	121
Machine Dimensions .....	121
Performance .....	122
Engine .....	122
Controls .....	122
Drive System .....	123
Hydraulic System .....	123
Electrical .....	124
Capacities .....	124
Tyres .....	124
Fuel Consumption .....	124
Environmental .....	124
Temperature Range .....	124



**Bobcat**®

**(S70) LOADER SPECIFICATIONS**

**Machine Dimensions**

- Dimensions are given for loader equipped with standard tyres and 36 in. dirt bucket and may vary with other bucket types. All dimensions are shown in millimeters. Respective imperial dimensions are given in inches enclosed by parentheses.
- Where applicable, specification conform to SAE or ISO standards and are subject to change without notice.

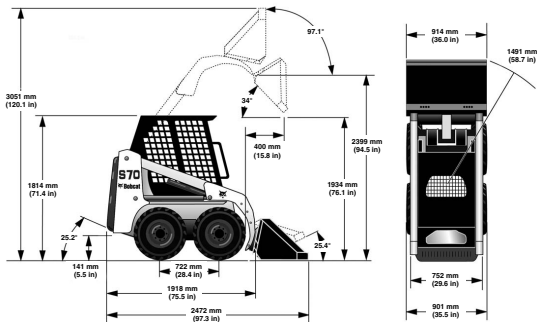

B-20824C

Changes of structure or weight distribution of the loader can cause changes in control and steering response and can cause failure of the loader parts.

#### (S70) LOADER SPECIFICATIONS (CONT'D)

##### Performance

Rated Operating Capacity (ISO)	318 kg (700 lb)
Tipping Load (ISO Rating)	686 kg (1512 lb)
Operating Weight	1268 kg (2795 lb)
SAE Breakout Force - Lift - Tilt	8607 N (1935 lb) 8674 N (1950 lb)
Travel Speed	0 - 9.8 km/h (0 - 6.1 MPH)
Push Force	9519 N (2140 lb)

##### Engine

Make / Model	Kubota / D1005-E3B-BC-3 Tier 4
Fuel / Cooling	Diesel / Liquid
Horsepower (SAE Net)	16,8 kW (22.5 hp) @ 3000 rpm
Torque (SAE Net)	62,8 N•m (45.6 ft-lb) @ 2200 rpm
Number of Cylinders	Three
Displacement	1.0 L (61.08 in <sup>3</sup> )
Bore / Stroke	76,0 mm / 73,6 mm (2.99 in / 2.90 in)
Lubrication	Gear Pump Pressure System with Filter
Crankcase Ventilation	Closed Breathing
Air Cleaner	Dry replaceable paper cartridge with separate safety element
Ignition	Diesel Compression
Air Induction	Naturally Aspirated
Low Idle	1125 - 1175 rpm
High Idle	3125 - 3175 rpm

##### Controls

Vehicle Steering	Direction and speed controlled by two hand operated steering levers.
Loader Hydraulics - Lift and Tilt  - Front Auxiliary Hydraulics (Std.)	Controlled by separate foot pedals.  Controlled by lateral movement of the right hand steering lever.
Engine	Hand lever speed control, key type start switch or optional keyless start and function error shutdown.
Starting Aid	Glow Plug - Automatically activated by Key Switch or Keyless instrumentation.
Service Brake	Two independent hydrostatic systems controlled by two hand operated steering levers.
Secondary Brake	One of the hydrostatic transmissions.
Parking Brake (Standard)	Mechanical disc, manually operated switch on front instrument panel.

**(S70) LOADER SPECIFICATIONS (CONT'D)**

**Drive System**

Main Drive	Hydrostatic 4 wheel drive
Transmission	Infinitely variable tandem hydrostatic piston pumps, driving two fully reversing hydrostatic motors.
Final Drive	Pre-stressed #60 HS endless roller chain (no master link) and sprockets in sealed chaincase with oil lubrication (Chains do not require periodic adjustments) Two chains per side with no idler sprocket
Total Engine to Wheel Reduction	31.25:1
Axle Size	37,6 mm (1.50 in), Heat treated
Wheel Bolts	Five - 9/16 in. Wheel bolts fixed to axle hubs

**Hydraulic System**

Pump Type	Engine driven gear type
Pump Capacity	33,7 L/min (8.9 U.S. gpm) @ 3150 engine rpm
Filters	Full flow replaceable, 10 micron synthetic media element
System Relief at Quick Couplers	20.7 MPa (207 bar) (3000 psi)
Hydraulic Cylinders	Double acting; Tilt cylinder has cushioning feature on dump and rollback
Bore Diameter: Lift Cylinder (2)	50,8 mm (2.00 in)
Tilt Cylinder (1)	76,2 mm (3.00 in)
Rod Diameter: Lift Cylinder (2)	31,8 mm (1.25 in)
Tilt Cylinder (1)	31,8 mm (1.25 in)
Stroke: Lift Cylinder (2)	555,5 mm (21.87 in)
Tilt Cylinder (1)	268,2 mm (10.56 in)
Control Valve	3-Spool, open centre type with spring detent for lift float and detent auxiliary hydraulic spool
Fluid Lines	SAE standard tubelines, hoses and fittings.
Hydraulic Function Time:	
Raise Lift Arms	3.6 Seconds
Lower Lift Arms	2.7 Seconds
Bucket Dump	2.1 Seconds
Bucket Rollback	1.7 Seconds

**(S70) LOADER SPECIFICATIONS (CONT'D)**

**Electrical**

Alternator	Belt driven, 65 amperes ventilated
Battery	12 volts, 600 cold cranking amperes @ -18°C (0°F) 115 minute reserve capacity at 25 amperes
Starter	12 volts, gear type, 2,7 kW (3.62 hp)
Instrumentation	<b>Gauges:</b> Hourmeter, temperature gauge, voltmeter, fuel gauge (on tank). <b>Warning lights:</b> Engine Oil Pressure, Hydrostatic Charge Pressure, Hydraulic Oil Temperature. <b>Other:</b> BICS™ Functions (on BICS™ Controller).

**Capacities**

Engine Cooling System	5,7 L (6.0 qt)
Fuel	24,6 L (6.5 U.S. gal)
Engine Lubrication with Filter	4,7 L (5.0 qt)
Hydraulic / Hydrostatic Reservoir	5 L (5.3 qt)
Hydraulic / Hydrostatic System	15,1 L (4.0 U.S. gal)
Chaincase Reservoir	11,4 L (3.0 U.S. gal)

**Tyres**

Standard Duty (Standard)	23 x 5.70 - 12, 4 Ply Rating
Heavy Duty (Option)	23 x 8.50 - 12, 6 Ply Rating
Recommended Pressure	Inflate tyres to MAXIMUM pressure shown on the side wall of the tyre. DO NOT mix brands of tyres used on the same loader.

**Fuel Consumption**

Engine Load	Full - 100%	High - 70%	Medium - 50%	Low - 30%
Fuel Consumption Rate Per Hour	5,56 L (1.47 U.S. gal)	3,71 L (0.98 U.S. gal)	3,03 L (0.8 U.S. gal)	2,65 L (0.7 U.S. gal)

**NOTE: The engine fuel consumption chart is to be used as a guideline only. The actual results may vary.**

**Environmental**

	Noise / Vibration Levels	Uncertainties (If Applicable)
Noise level LpA (EU Directive 2000/14/EC)	97 dB(A)	---
Operator position noise level (ISO 6396)	87,6 dB(A)	---
Whole body vibration (ISO 2631-1) (limit 0,5 m/s <sup>2</sup> )	0,227 m/s <sup>2</sup>	---
Hand-arm vibration (ISO 5349-1) (limit 2,5 m/s <sup>2</sup> )	1,426 m/s <sup>2</sup>	---

**Temperature Range**

Operation and storage	-21 - +43°C (-5.8 - +109.4°F)
-----------------------	-------------------------------



**\*Always follow manufacturer instructions\***



Torkonjestraat 23  
8510 Marke  
Belgium



056 / 222 111



rental@dumarent.be



www.dumarent.be

**WARRANTY**

WARRANTY ..... 127



**\* Always follow manufacturer instructions \***

**d**

Torkonjestraat 23  
8510 Marke  
Belgium



056 / 222 111



rental@dumarent.be



www.dumarent.be



**Bobcat®**



WARRANTY

# WARRANTY

## BOBCAT LOADERS

DOOSAN BENELUX S.A. warrants to its authorised dealers who in turn warrant to the end-user / owner that each new Bobcat loader will be free from proven defects in material and workmanship for twelve months from the date of delivery to the end-user / owner or 2000 hours of machine usage, whichever occurs first.

During the warranty period, the authorised selling Bobcat dealer shall repair or replace, at DOOSAN BENELUX S.A.'s option, without charge for parts, labour and travel time of mechanics, any part of the Bobcat product which fails because of defects in material and workmanship. The end-user / owner shall provide the authorised Bobcat dealer with prompt written notice of the defect and allow reasonable time for replacement or repair. DOOSAN BENELUX S.A. may, at its option, request failed parts to be returned to the factory. Transportation of the Bobcat product to the authorised Bobcat dealer for warranty work is the responsibility of the end-user / owner.

Service schedules must be adhered to, documented and genuine parts / lubricants must be used. The warranty does not cover oils and lubricants, coolant fluids, filter elements, tune-up parts, bulbs, fuses, ignition system parts (glow plugs, fuel injection pumps, injectors), alternator fan belts, drive belts and other high-wear items. Pins and bushings are considered to be normal consumable items and are not warranted.

The warranty does not apply to tyres or other trade accessories not manufactured by Bobcat. The owner shall rely solely on the warranty, if any, of the respective manufacturers thereof. The warranty does not cover damages resulting from abuse, accidents, alterations, use of the Bobcat product with any bucket or attachment not approved by Bobcat, air flow obstructions, or failure to maintain or use the Bobcat product according to the instructions applicable to it.

DOOSAN BENELUX S.A. EXCLUDES OTHER CONDITIONS, WARRANTIES OR REPRESENTATIONS OF ALL KINDS, EXPRESSED OR IMPLIED, STATUTORY OR OTHERWISE (EXCEPT THAT OF TITLE) INCLUDING ALL IMPLIED WARRANTIES AND CONDITIONS RELATING TO MERCHANTABILITY, SATISFACTORY QUALITY AND FITNESS FOR A PARTICULAR PURPOSE.

CORRECTIONS BY DOOSAN BENELUX S.A. OF NONCONFORMITIES WHETHER PATENT OR LATENT, IN THE MANNER AND FOR THE TIME PERIOD PROVIDED ABOVE, SHALL CONSTITUTE FULFILMENT OF ALL LIABILITIES OF DOOSAN BENELUX S.A. FOR SUCH NONCONFORMITIES, WHETHER BASED ON CONTRACT, WARRANTY, TORT, NEGLIGENCE, INDEMNITY, STRICT LIABILITY OR OTHERWISE WITH RESPECT TO OR ARISING OUT OF SUCH PRODUCT.

THE REMEDIES OF THE END-USER / OWNER SET FORTH UNDER THE PROVISIONS OF THE WARRANTY OUTLINED ABOVE ARE EXCLUSIVE AND THE TOTAL LIABILITY OF DOOSAN BENELUX S.A. INCLUDING ANY HOLDING, SUBSIDIARY, ASSOCIATED OR AFFILIATED COMPANY OR DISTRIBUTOR WITH RESPECT TO THIS SALE OR THE PRODUCT AND SERVICE FURNISHED HEREUNDER IN CONNECTION WITH THE PERFORMANCE OR BREACH THEREOF, OR FROM DELIVERY, INSTALLATION, REPAIR OR TECHNICAL DIRECTION COVERED BY OR FURNISHED UNDER THIS SALE, WHETHER BASED ON CONTRACT, WARRANTY, TORT, NEGLIGENCE, INDEMNITY, STRICT LIABILITY OR OTHERWISE SHALL NOT EXCEED THE PURCHASE PRICE OF THE PRODUCT UPON WHICH SUCH LIABILITY IS BASED.

DOOSAN BENELUX S.A. INCLUDING ANY HOLDING, SUBSIDIARY, ASSOCIATED OR AFFILIATED COMPANY AND DISTRIBUTOR SHALL IN NO EVENT BE LIABLE TO THE END-USER / OWNER, ANY SUCCESSORS IN INTEREST OR ANY BENEFICIARY OR ASSIGNEE RELATING TO THIS SALE FOR ANY CONSEQUENTIAL, INCIDENTAL, INDIRECT, SPECIAL OR PUNITIVE DAMAGES ARISING OUT OF THIS SALE OR BY ANY BREACH THEREOF, OR ANY DEFECT IN, OR FAILURE OF, OR MALFUNCTION OF THE PRODUCT UNDER THIS SALE, WHETHER BASED UPON LOSS OF USE, LOST PROFITS OR REVENUE, INTEREST, LOST GOODWILL, WORK STOPPAGE, IMPAIRMENT OF OTHER GOODS, LOSS BY REASON OF SHUTDOWN OR NON-OPERATION, INCREASED EXPENSES OF OPERATION OR CLAIMS OF USER OR CUSTOMERS OF THE USER FOR SERVICE INTERRUPTION WHETHER OR NOT SUCH LOSS OR DAMAGE IS BASED ON CONTRACT, WARRANTY, TORT, NEGLIGENCE, INDEMNITY, STRICT LIABILITY OR OTHERWISE.



**Bobcat**®

4700002-EN (1-10)

Printed in Belgium



**\* Always follow manufacturer instructions \***

**d**

Torkonjestraat 23  
8510 Marke  
Belgium



056 / 222 111



rental@dumarent.be



www.dumarent.be



**Bobcat®**

## ALPHABETICAL INDEX

(S70) LOADER SPECIFICATIONS	121	LUBRICATING THE LOADER	108
AIR CLEANER SERVICE	89	MACHINE SIGNS (DECALS)	24
ALTERNATOR BELT	106	MAINTENANCE SAFETY	73
ATTACHMENT CONTROL DEVICE (ACD)	46	MONITORING THE DISPLAY PANELS	56
ATTACHMENTS	58	OPERATING PROCEDURE	62
BACK-UP ALARM SYSTEM	40	OPERATOR CAB	85
BACK-UP ALARM SYSTEM	83	OPERATOR SAFETY WARNINGS	1
BOBCAT COMPANY IS ISO 9001 CERTIFIED	9	PARKING BRAKE	37
BOBCAT INTERLOCK CONTROL SYSTEM (BICSTM)	117	PIVOT PINS	110
BOBCAT INTERLOCK CONTROL SYSTEM (BICSTM)	36	PRE-STARTING PROCEDURE	49
BOBCAT INTERLOCK CONTROL SYSTEM (BICSTM)	77	PUBLICATIONS AND TRAINING RESOURCES	27
BOB-TACH	111	REAR DOOR (TAILGATE)	88
CONTROL IDENTIFICATION	34	REGULAR MAINTENANCE ITEMS	9
DAILY INSPECTION	47	SAFETY INSTRUCTIONS	19
DECLARATION OF CONFORMITY	7	SEAT BAR RESTRAINT SYSTEM	35
DELIVERY REPORT	11	SEAT BAR RESTRAINT SYSTEM	79
DRIVE BELT	107	SEAT BELT	80
DRIVING AND STEERING THE LOADER	42	SERIAL NUMBER LOCATIONS	11
ELECTRICAL SYSTEM	96	SERVICE SCHEDULE	75
EMERGENCY EXIT	39	SPARK ARRESTER MUFFLER	103
ENGINE COOLING SYSTEM	94	STARTING THE ENGINE	52
ENGINE LUBRICATION SYSTEM	93	STOPPING THE ENGINE AND LEAVING THE LOADER	57
ENGINE SPEED CONTROL	41	STOPPING THE LOADER	42
FEATURES, ACCESSORIES AND ATTACHMENTS	13	TOWING THE LOADER	66
FINAL DRIVE TRANSMISSION (CHAINCASE)	105	TRACTION LOCK OVERRIDE	38
FIRE PREVENTION	21	TRANSPORTING THE LOADER ON A TRAILER	67
FUEL SYSTEM	90	TROUBLESHOOTING	115
HYDRAULIC CONTROLS	43	TYRE MAINTENANCE	104
HYDRAULIC / HYDROSTATIC SYSTEM	100	WARRANTY	127
INSTRUMENT PANEL IDENTIFICATION	31		
LIFT ARM BYPASS CONTROL	37		
LIFT ARM SUPPORT DEVICE	81		
LIFTING THE LOADER	67		
LOADER IDENTIFICATION	12		
LOADER STORAGE AND RETURN TO SERVICE	112		
LUBRICANTS AND FLUIDS	10		



**Bobcat**®



**\*Always follow manufacturer instructions\***

**d** Torkonjestraat 23  
8510 Marke  
Belgium



056 / 222 111



rental@dumarent.be



www.dumarent.be

**\*AAA Rent-All 225-291-1356\***



**\*Always follow manufacturer instructions\***



Torkonjestraat 23  
8510 Marke  
Belgium



056 / 222 111



rental@dumarent.be



www.dumarent.be

**\*AAA Rent-All 225-291-1356\***



**\*Always follow manufacturer instructions\***

**d** Torkonjestraat 23  
8510 Marke  
Belgium



056 / 222 111



rental@dumarent.be



www.dumarent.be

**\*AAA Rent-All 225-291-1356\***